



<b>SPECIFICATIONS</b>
-----------------------

	KV-32XBR200	KV-36XBR200
Power requirements	120V, 60Hz	
Number of inputs/outputs:		
Video <sup>1)</sup>	3	
S Video <sup>2)</sup>	2	
Audio <sup>3)</sup>	4	
Audio Out <sup>4)</sup>	1	
Monitor Out	1	
TV Out <sup>1) 3)</sup>	1	
S-link	3	
Y, PB, PR <sup>5)</sup>	1	
Speaker output (W)	15W x 2	
Power Consumption (W):		
In use (max.)	240W	
In standby	2W	
Dimensions (W/H/D):		
(mm)	889.4 x 685.6 x 600.7 mm	1010 x 761.2 x 630.9 mm
(in.)	35 <sup>7/16</sup> x 27 x 23 <sup>21/32</sup> in	35 <sup>13/16</sup> x 30 x 24 <sup>15/16</sup> in
Mass:		
(kg.)	79 kg	107 kg
(lbs.)	175 lbs	236 lbs

<sup>1)</sup> 1 Vp-p 75 ohms unbalanced, sync negative

<sup>2)</sup> Y: 1 Vp-p 75 ohms unbalanced, sync negative

  C: 0.286 Vp-p (Burst signal), 75 ohms

<sup>3)</sup> 500 mVrms (100% modulation), Impedance: 47 kilohms

<sup>4)</sup> More than 408 mVrms at the maximum volume setting (variable)  
More than 408 mVrms (fix); Impedance (Output): 2 kilohms

<sup>5)</sup> Y: 1.0 Vp-p, 75 ohms, sync negative; PB: 0.7 Vp-p, 75 ohms; PR: Vp-p, 75 ohms

**Television system**

American TV standard, NTSC

**Channel coverage**

VHF:2-13 / UHF:14-69 / CATV:1-125

**Visible screen size**

32-inch picture measured diagonally (KV-32XBR200)

36-inch picture measured diagonally (KV-36XBR200)

**Actual screen size**

34-inch picture measured diagonally (KV-32XBR200)

38-inch picture measured diagonally (KV-36XBR200)

**Antenna**

75 ohm external antenna terminal for VHF/UHF

**Picture tube**

FD Trinitron® tube

**Supplied accessories**

Remote control RM-Y144

Battery size AA (R6) 2

**Optional accessory**

Connecting Cables

RK-74A, RK-G69HG,

VMC-10HG, VMC-720M,

VMC-810S/820S, YC-15V/30V,

TV Stand SU-32FD1, SU-36FD1

U/V mixer EAC-66

<b>( ● ) ® SRS (SOUND RETRIEVAL SYSTEM)</b>
---

The ( ● ) SRS (SOUND RETRIEVAL SYSTEM) is manufactured by Sony Corporation under license from SRS Labs, Inc. It is covered by U.S. Patent No. 4,748,669. Other U.S. and foreign patents pending.

The word 'SRS' and the SRS symbol ( ● ) are registered trademarks of SRS Labs, Inc.

BBE and BBE symbol are trademarks of BBE Sound, Inc. and are licensed by BBE Sound, Inc. under U.S. Patent No. 4,638,258 and 4,482,866.

*Design and specifications are subject to change without notice.*

## TABLE OF CONTENTS

<u>Section</u>	<u>Title</u>	<u>Page</u>	<u>Section</u>	<u>Title</u>	<u>Page</u>
<b>1. GENERAL</b>			<b>3. SET-UP ADJUSTMENTS</b>		
	Remote Control.....	5	3-1.	Beam Landing.....	16
	Connecting and Installing the TV.....	5	3-2.	Convergence.....	17
	Cable Box Connections.....	5	3-3.	Focus.....	18
	VCR Connections.....	5	3-4.	Screen (G2).....	18
	DBS Connections.....	6	3-5.	White Balance Adjustment.....	18
	DVD Player Connections.....	6	<b>4. SAFETY RELATED ADJUSTMENTS.....</b>		<b>19</b>
	Additional Connections.....	6	<b>5. CIRCUIT ADJUSTMENTS.....</b>		<b>20</b>
	Using your New TV.....	7	<b>6. DIAGRAMS</b>		
	Watching the TV.....	8	6-1.	Block Diagram.....	31
	Watching two programs at one time - PIP.....	8	6-2.	Circuit Boards Location.....	34
	Using Your Menus.....	9	6-3.	Printed Wiring Boards and Schematic Diagrams.....	39
	Learning menu selection.....	9	• A Board.....	39	
	Using the VIDEO menu.....	9	• AX Board.....	45	
	Using the AUDIO menu.....	10	• BX Board.....	47	
	Using the TIMER menu.....	10	• HF Board.....	50	
	Using the SET UP menu.....	10	• HX Board.....	50	
	Operating Video Equipment.....	12	• C Board.....	51	
	VCR manufacturer code numbers.....	12	• G Board.....	53	
	MDP manufacturer code numbers.....	12	• K Board.....	55	
	Operating a cable box DBS or DBS receiver.....	12	• WA Board.....	57	
	Troubleshooting.....	12	• PX Board.....	59	
			• UX Board.....	63	
<b>2. DISASSEMBLY</b>			6-4.	Semiconductors.....	68
2-1.	Rear Cover and Speaker Removal.....	13	<b>7. EXPLODED VIEWS</b>		
2-2.	Chassis Assembly Removal.....	13	7-1.	Chassis.....	69
2-3.	Service Position.....	13	7-2.	Picture Tube.....	70
2-4.	Control Assy Removal.....	13	<b>8. ELECTRICAL PARTS LIST.....</b>		<b>71</b>
2-5.	Extension Cable Removal.....	14			
2-6.	Picture Tube Removal.....	15			

### CAUTION!

SHORT CIRCUIT THE ANODE OF THE PICTURE TUBE AND THE ANODE CAP TO THE METAL CHASSIS, CRT SHIELD, OR CARBON PAINTED ON THE CRT, AFTER REMOVING THE ANODE.

### WARNING!!

AN ISOLATION TRANSFORMER SHOULD BE USED DURING ANY SERVICE TO AVOID POSSIBLE SHOCK HAZARD, BECAUSE OF LIVE CHASSIS.  
THE CHASSIS OF THIS RECEIVER IS DIRECTLY CONNECTED TO THE AC POWER LINE.

### SAFETY-RELATED COMPONENT WARNING!!

COMPONENTS IDENTIFIED BY SHADING AND MARK  $\triangle$  ON THE SCHEMATIC DIAGRAMS, EXPLODED VIEWS AND IN THE PARTS LIST ARE CRITICAL FOR SAFE OPERATION. REPLACE THESE COMPONENTS WITH SONY PARTS WHOSE PART NUMBERS APPEAR AS SHOWN IN THIS MANUAL OR IN SUPPLEMENTS PUBLISHED BY SONY. CIRCUIT ADJUSTMENTS THAT ARE CRITICAL FOR SAFE OPERATION ARE IDENTIFIED IN THIS MANUAL. FOLLOW THESE PROCEDURES WHENEVER CRITICAL COMPONENTS ARE REPLACED OR IMPROPER OPERATION IS SUSPECTED.

### ATTENTION

APRES AVOIR DECONNECTE LE CAP DE L'ANODE, COURT-CIRCUITER L'ANODE DU TUBE CATHODIQUE ET CELUI DE L'ANODE DU CAP AU CHASSIS METALLIQUE DE L'APPAREIL, OU AU COUCHE DE CARBONE PEINTE SUR LE TUBE CATHODIQUE OU AU BLINDAGE DU TUBE CATHODIQUE.

### ATTENTION!!

AFIN D'EVITER TOUT RESQUE D'ELECTROCUTION PROVENANT D'UN CHÂSSIS SOUS TENSION, UN TRANSFORMATEUR D'ISOLEMENT DOIT ETRE UTILISÉ LORS DE TOUT DÉPANNAGE. LE CHÂSSIS DE CE RÉCEPTEUR EST DIRECTEMENT RACCORDÉ À L'ALIMENTATION SECTEUR.

### ATTENTION AUX COMPOSANTS RELATIFS A LA SECURITE!!

LES COMPOSANTS IDENTIFIES PAR UNE TRAME ET PAR UNE MARQUE  $\triangle$  SUR LES SCHEMAS DE PRINCIPE, LES VUES EXPLOSEES ET LES LISTES DE PIECES SONT D'UNE IMPORTANCE CRITIQUE POUR LA SECURITE DU FONCTIONNEMENT. NE LES REMPLACER QUE PAR DES COMPOSANTS SONY DONT LE NUMERO DE PIECE EST INDIQUE DANS LE PRESENT MANUEL OU DANS DES SUPPLEMENTS PUBLIES PAR SONY. LES REGLAGES DE CIRCUIT DONT L'IMPORTANCE EST CRITIQUE POUR LA SECURITE DU FONCTIONNEMENT SONT IDENTIFIES DANS LE PRESENT MANUEL. SUIVRE CES PROCEDURES LORS DE CHAQUE REMPLACEMENT DE COMPOSANTS CRITIQUES, OU LORSQU'UN MAUVAIS FONCTIONNEMENT SUSPECTE.

## SAFETY CHECK-OUT

After correcting the original service problem, perform the following safety checks before releasing the set to the customer:

1. Check the area of your repair for unsoldered or poorly-soldered connections. Check the entire board surface for solder splashes and bridges.
2. Check the interboard wiring to ensure that no wires are "pinched" or contact high-wattage resistors.
3. Check that all control knobs, shields, covers, ground straps, and mounting hardware have been replaced. Be absolutely certain that you have replaced all the insulators.
4. Look for unauthorized replacement parts, particularly transistors, that were installed during a previous repair. Point them out to the customer and recommend their replacement.
5. Look for parts which, though functioning, show obvious signs of deterioration. Point them out to the customer and recommend their replacement.
6. Check the line cords for cracks and abrasion. Recommend the replacement of any such line cord to the customer.
7. Check the B+ and HV to see if they are specified values. Make sure your instruments are accurate; be suspicious of your HV meter if sets always have low HV.
8. Check the antenna terminals, metal trim, "metallized" knobs, screws, and all other exposed metal parts for AC Leakage. Check leakage as described below.

### LEAKAGE TEST

The AC leakage from any exposed metal part to earth ground and from all exposed metal parts to any exposed metal part having a return to chassis, must not exceed 0.5 mA (500 microampere). Leakage current can be measured by any one of three methods.

1. A commercial leakage tester, such as the Simpson 229 or RCA WT-540A. Follow the manufacturers' instructions to use these instructions.
2. A battery-operated AC milliammeter. The Data Precision 245 digital multimeter is suitable for this job.
3. Measuring the voltage drop across a resistor by means of a VOM or battery-operated AC voltmeter. The "limit" indication is 0.75 V, so analog meters must have an accurate low voltage scale. The Simpson's 250 and Sanwa SH-63Trd are examples of passive VOMs that are suitable. Nearly all battery operated digital multimeters that have a 2V AC range are suitable. (See Fig. A)

### HOW TO FIND A GOOD EARTH GROUND

A cold-water pipe is guaranteed earth ground; the cover-plate retaining screw on most AC outlet boxes is also at earth ground. If the retaining screw is to be used as your earth-ground, verify that it is at ground by measuring the resistance between it and a cold-water pipe with an ohmmeter. The reading should be zero ohms. If a cold-water pipe is not accessible, connect a 60-100 watts trouble light (not a neon lamp) between the hot side of the receptacle and the retaining screw. Try both slots, if necessary, to locate the hot side of the line, the lamp should light at normal brilliance if the screw is at ground potential. (See Fig. B)

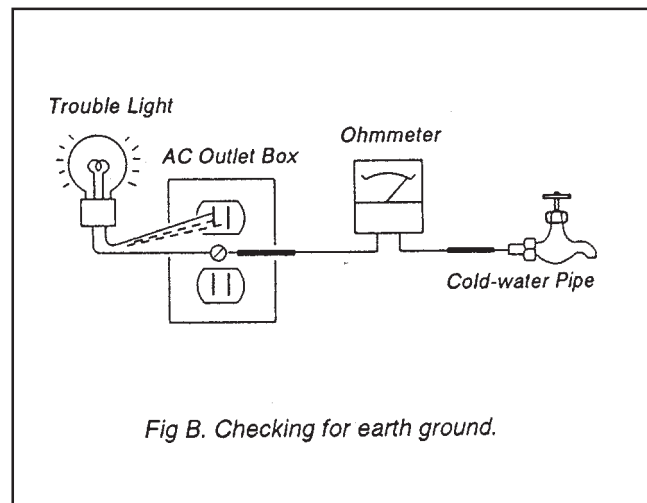
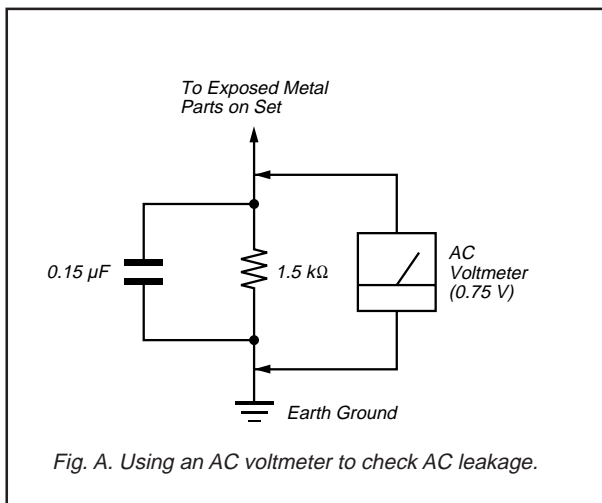

# SECTION 1 GENERAL

The instructions mentioned here are partial abstracts from the Operating Instruction Manual. The page numbers shown reflect those of the Operating Instruction Manual.

## Remote Control

In the instructions that follow, we will refer to the buttons on your remote control. Keep this flap unfolded and use this page for reference.

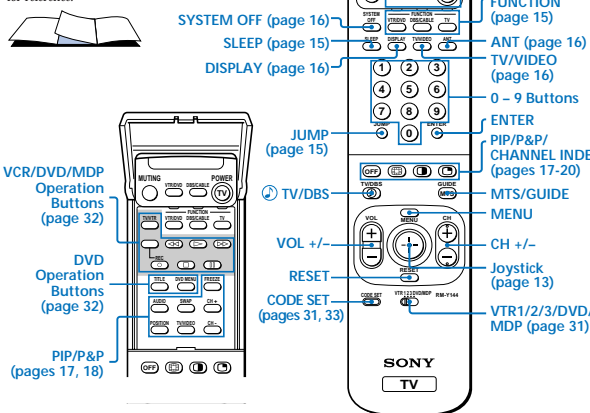

### Getting to know the buttons on the remote control

Names of the buttons on the remote control are presented in different colors to represent the available functions.

#### Button color

- Black ..... Press to select the component you want to control; e.g. VTR (VCR)/MDP/DVD Player, DBS (Direct Broadcast Satellite)/CABLE, or TV
- Green ..... Buttons relevant to power operations, like turning the TV, DBS (Direct Broadcast Satellite)/CABLE, or VTR (VCR)/MDP/DVD Player on or off

#### Label color

- White ..... TV/VTR (VCR)/MDP/DVD Player/DBS (Direct Broadcast Satellite)/CABLE operation buttons
- Yellow ..... PIP, P&P, and CHANNEL INDEX operation buttons
- Blue ..... DBS (Direct Broadcast Satellite) operation buttons
- Green ..... S-Link operation buttons
- Pink ..... DVD Player operation buttons

For a detailed explanation of most buttons, see "Watching the TV" on page 15.

## Connecting and Installing the TV (continued)

### Cable Box Connections

Some pay cable TV systems use scrambled or encoded signals that require a cable box to view all channels.

#### Cable box

- 1 Connect the coaxial connector from your cable to the IN on your cable box.
- 2 Using a coaxial cable, connect OUT on your cable box to VHF/UHF on your TV.

If you will be controlling all channel selection through your cable box, you should consider using the CHANNEL FIX feature. (see "CHANNEL SET UP" on page 26)

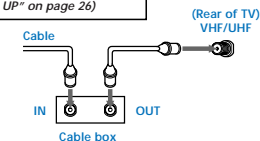

#### Cable box and cable

For this set up, you can switch between scrambled channels (through your cable box), and normal (CATV) channels by pressing ANT on your remote control.

#### Notes

- Your Sony remote control can be programmed to operate your cable box. (see "Operating a Cable Box or DBS Receiver" on page 33)
- When using PIP, you cannot view the AUX input in the window picture.

#### Tip

Pressing ANT switches between these inputs.

4

If you are connecting a cable box through the AUX input and would like to switch between the AUX and normal (CATV) input you should consider using the CHANNEL FIX feature. (see "CHANNEL SET UP" on page 26)

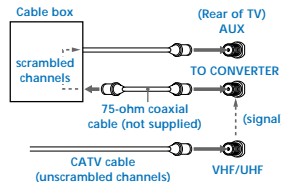

## VCR Connections

### Connecting an antenna/cable TV system with a VCR

- 1 Attach the coaxial connector from your cable or antenna to IN on your VCR.
- 2 Using A/V connectors, connect AUDIO and VIDEO OUT on your VCR to AUDIO and VIDEO IN on your TV\*.
- 3 Using a coaxial connector, connect OUT on your VCR to VHF/UHF on your TV\*.

\* If you are connecting a monaural VCR, connect only the single white audio output to the left input on your TV.

Disconnect all power sources before making any connections.

For optimum picture quality, use S VIDEO instead of the yellow AV cable. S VIDEO does not provide sound, your audio connectors must still be connected.

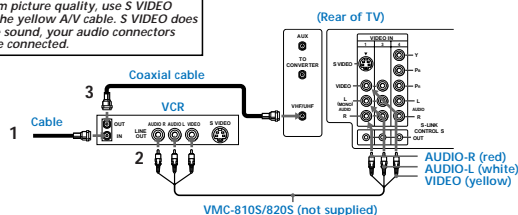

### Connecting a VCR and TV with a cable box

- 1 Connect the single (input) jack of the splitter to your incoming cable connection, and connect the other two (output) jacks (using coaxial cable) to IN on your cable box and VHF/UHF on your TV.
- 2 Using a coaxial connector, connect OUT on your cable box to IN on your VCR.
- 3 Using A/V connectors, connect AUDIO and VIDEO OUT on your VCR to AUDIO and VIDEO IN on your TV.

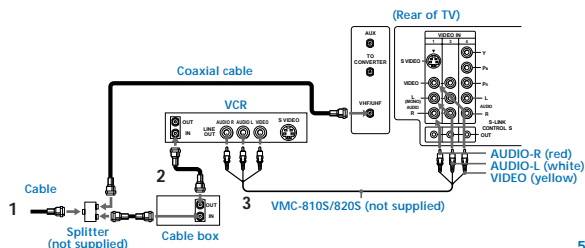

## Connecting and Installing the TV (continued)

### Connecting two VCRs

MONITOR OUT gives you the ability to use a second VCR to record a program being played by the primary VCR or to perform tape editing and dubbing.

- 1 Connect the VCR intended for playback using the connection instructions on page 4 of this manual.
- 2 Using A/V connectors, connect AUDIO and VIDEO IN on your VCR intended for recording to MONITOR AUDIO and VIDEO OUT on your TV.

Do not change the input signal while editing through MONITOR OUT.

Disconnect all power sources before making any connections.

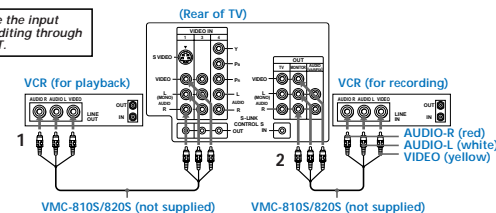

## DBS Connections

### Connecting a DBS (Direct Broadcast Satellite) receiver

- 1 Connect the cable from your satellite antenna to your DBS receiver.
- 2 Attach the coaxial connector from your cable or antenna to VHF/UHF on your TV.
- 3 Using A/V connectors, connect AUDIO and VIDEO OUT on your DBS receiver to AUDIO and VIDEO IN on your TV.

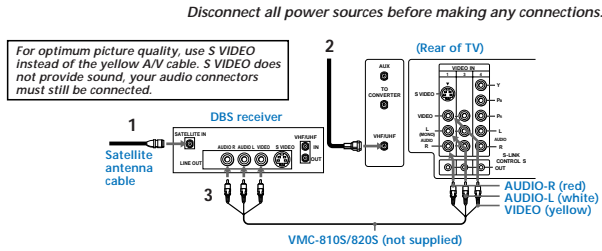

### Connecting a DBS (Direct Broadcast Satellite) receiver and a VCR

- 1 Connect the cable from your satellite antenna to your DBS receiver.
- 2 Attach the coaxial connector from your cable or antenna to VHF/UHF IN on your VCR.
- 3 Using a coaxial connector, connect VHF/UHF OUT on your VCR to VHF/UHF on your TV.
- 4 Using A/V connectors, connect AUDIO and VIDEO OUT on your DBS receiver to AUDIO and VIDEO IN on your VCR.
- 5 Using A/V connectors, connect AUDIO and VIDEO OUT on your VCR to AUDIO and VIDEO IN on your TV.

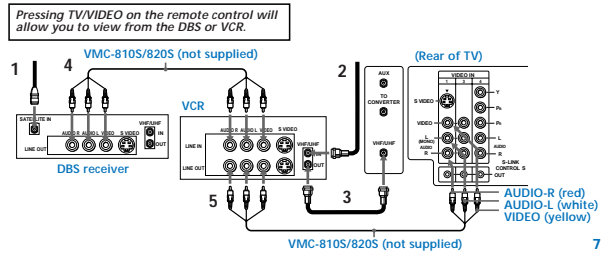

## Additional Connections

### Connecting an audio system

For an enhanced sound, connect your audio system to your TV.

- 1 Using AUDIO connectors, connect AUDIO OUT on your TV to one of the unused Line inputs (e.g. Tape-2, AUX1, etc.) on your stereo.
- 2 Set your stereo to the chosen Line input and use the AUDIO menu to set your audio output. (see "SPEAKER" and "AUDIO OUT" on page 24)

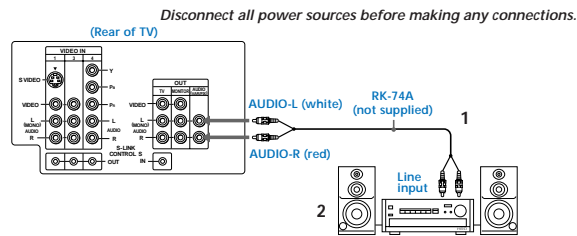

### Connecting an A/V receiver

For easier control of all audio and video equipment, connect your A/V receiver.

- 1 Using A/V connectors, connect VIDEO 1 IN on your TV to Monitor AUDIO and VIDEO OUT on your A/V receiver.
- 2 Using A/V connectors, connect TV OUT on your TV to TV AUDIO and VIDEO IN on your A/V receiver.



You may want to use CHANNEL FIX to fix your TV's input to the A/V receiver (VIDEO 1). (see "CHANNEL SET UP" on page 26)

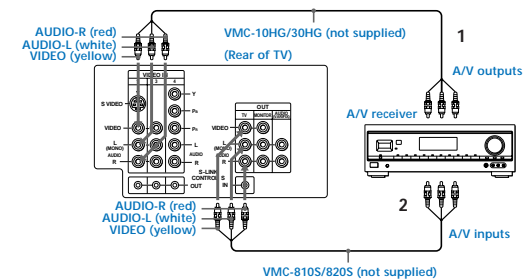

## Connecting and Installing the TV (continued)

### DVD Connections

#### Connecting a DVD Player

Using A/V connectors, connect VIDEO IN on your TV to LINE OUT on your DVD Player.

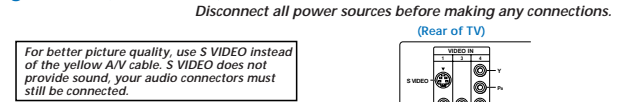

#### Connecting a DVD Player with component video output connectors

This connection option offers the highest quality DVD picture.

- 1 Using AUDIO connectors, connect AUDIO R and L of the LINE OUT on your DVD Player to AUDIO R and L on the VIDEO IN 4 panel at the rear of your TV.
- 2 Using three VIDEO connectors, connect Y, Pb, and Pr on the COMPONENT VIDEO OUT on your DVD Player to Y, Pb, and Pr on the VIDEO IN 4 panel at the rear of your TV.

**Note**

- Some DVD Player terminals may be labeled Y, Cb, and Cr, or Y, B-Y, and R-Y. If so, connect them by matching the colors.

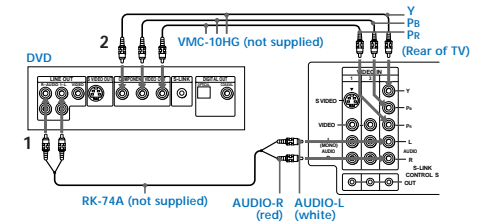

## Connecting and Installing the TV (continued)

### Connecting a camcorder

This connection is convenient for viewing a picture directly from your camcorder. Using A/V connectors, connect AUDIO and VIDEO OUT on your camcorder to AUDIO and VIDEO IN on your TV.

Connection can also be made directly to your A/V input located on the rear of your TV.

**Note**

- If you are connecting a monaural camcorder, connect only the single white audio output to the left input on your TV.

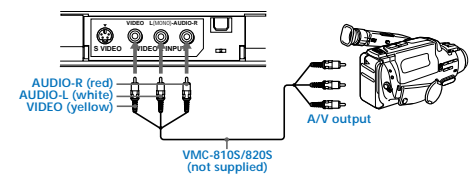
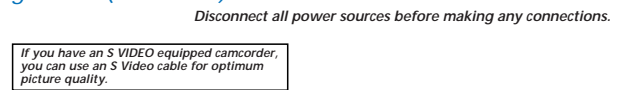

## Using Special Sony Features

### Using the CONTROL S feature

CONTROL S allows you to control your TV and other Sony equipment with one remote control.

To control your other Sony equipment with your TV's remote control, connect the CONTROL S IN jack of the equipment to the CONTROL S OUT jack on the TV with the CONTROL S cable.

To control other Sony equipment with your TV's remote control, see "S-Link Connections" on page 12.

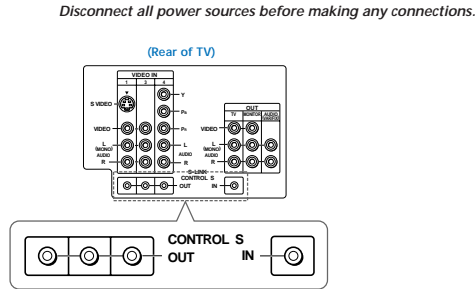

11

## Connecting and Installing the TV (continued)

### Connecting S-Link to your VCR

S-Link will automatically power on the TV and switch to the correct video input when a tape is inserted in the VCR or when you begin to play a tape.

- Using A/V connectors, connect AUDIO and VIDEO OUT on your VCR to AUDIO and VIDEO IN on your TV.
- Using an S-LINK connector (mono mini plug), connect S-LINK/CONTROL S-IN on your VCR to S-LINK on your TV.

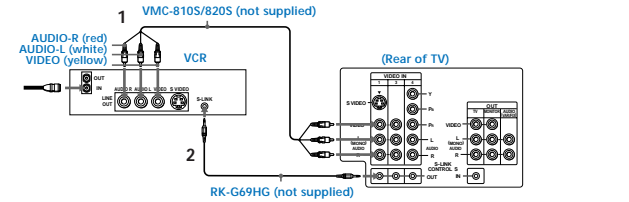

### Connecting S-Link to your DBS

S-Link will automatically power on the TV and switch to the correct video input when you power on the DBS.

- Using A/V connectors, connect AUDIO and VIDEO OUT on your DBS to AUDIO and VIDEO IN on your TV.
- Using an S-LINK connector (mono mini plug), connect S-LINK/CONTROL S-IN on your DBS to S-LINK on your TV.

#### Note

- If you have labeled one of your video inputs as SKIP (see "VIDEO LABEL" on page 27) and then connect video equipment to this input using S-Link, the S-Link feature will override the SKIP function.

The S-Link connector must be in the same VIDEO-IN jacks as the A/V cables on your TV.

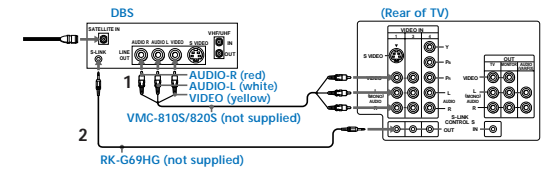

12

## Basic Set Up

### Inserting Batteries

Insert two size AA (R6) batteries (supplied) by matching the + and - on the batteries to the diagram inside the battery compartment.



#### Notes

- Remove the batteries to avoid damage from possible battery leakage whenever you anticipate that the remote control will not be used for an extended period.
- Handle the remote control with care. Avoid dropping it, getting it wet, or placing it in direct sunlight, near a heater, or where the humidity is high.
- Your remote control can be programmed to operate most video equipment. (see "Operating Video Equipment" on page 31)

### Using the Remote Control Joystick

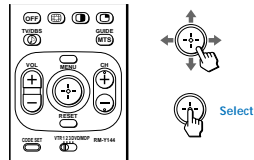

The supplied remote control has a joystick which allows for movement of the on-screen selector. Pressing up, down, left, or right on the joystick will cause the selector to move in the corresponding direction. Pressing down on the center of the joystick (⊕) will select the item.

### Adjustment Bars

When menu items present an adjustment bar (▬ or ▬), press up, down, left, or right on the joystick to adjust the setting.

### On Screen Help/Instructions

Several menu windows will provide prompts and instructions to assist you in navigating through the different functions.

When the instructions are presented, use them to supplement the instructions in this manual.

13

## Using your New TV

### Setting Up the TV Automatically

The Easy Setup Guide feature allows you to set the on-screen language and set all receivable channels in one step.

The AUTO PROGRAM function of the Easy Setup Guide feature does not apply for installations that use a cable box for all channel selection.

You can also set up the TV manually. (see "Using the SET UP menu" on page 26)

#### Tips

- Perform this function during the day, with the antenna and/or cable properly connected, to ensure that all available channels will be broadcasting and receivable.
- After using Easy Setup Guide you will still have the option of adjusting any of the system settings, like erasing channels, through the SET UP menu. (see "CHANNEL SET UP" on page 26)

Using the buttons on the top of the TV:



- Press POWER to turn on the TV. The Easy Setup Guide screen appears.



- Press CHANNEL + to select ENGLISH, CHANNEL - to select ESPAÑOL or VOLUME + to select FRANÇAIS. The screen will change to reflect your choice.



For a DEMO of functions and menus, press TV/VIDEO.

14

- Press VOLUME - to continue.



AUTO PROGRAM appears and the TV starts scanning and presetting channels automatically. When all the receivable channels are stored, the lowest numbered channel is displayed. If the TV receives cable TV channels, CABLE is set to ON automatically.

#### To perform AUTO SET UP again

Press the SET UP button on the TV and follow steps 2-3.

#### Notes

- Before you perform Easy Setup Guide again, make sure that the input from ANT (not AUX) is selected by pressing ANT until "AUX" does not appear next to the channel number.
- When you perform AUTO PROGRAM, your CHANNEL FIX, TIMER, and CHANNEL BLOCK settings will be erased.
- To reset your TV to factory settings, turn the TV on. Then, while pressing the RESET button on your remote control, press the POWER key on your TV. The TV will turn itself off, then back on.

### Watching the TV

Many TV features can be accessed directly through the remote control. The following chart will explain the function of some buttons found on your remote control.



REFER TO THE ILLUSTRATION OF THE REMOTE CONTROL ON THE INSIDE FRONT COVER OF THIS MANUAL AS YOU REVIEW THIS CHART

Using the White Labeled Buttons for TV Operations	
	Press when you want to turn equipment on and off.
	Press when you want to control connected components with your remote control. (see pages 31-33 for instructions on programming your remote control)
	Use for direct channel selection. Press 0-9 to select a channel (for example, to select channel 10, press 1 and 0), the channel will change after 2 seconds, or you can press ENTER for immediate selection.
	Press to scan through the channels. Keeping the CH + or - pressed allows you to rapidly scan to the desired channel.
	Press to adjust the volume.
	Press to alternate or jump back and forth between two channels. The TV will jump between the current channel and the last channel selected using the 0-9 buttons.
	Press to mute the sound ("MUTING" will appear on the screen). Press again or press VOL + to restore sound.
	Press to freeze the picture. Press again or press OFF to cancel.
	Press repeatedly until the TV displays the approximate time in minutes (30, 60, or 90) that you want the TV to remain on before shutting off automatically. Cancel by pressing until SLEEP OFF appears.

15

### Watching Two Programs at One Time — PIP/P&P (Twin View™)

The Picture-in-Picture (PIP) feature allows you to view two channels simultaneously, one in the full size "main" picture and one in a smaller "window" picture.

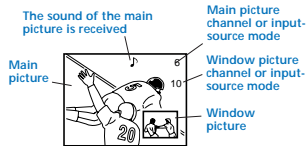

The Picture-and-Picture (P&P) feature allows you to view two channels simultaneously, both in a reduced size screen. The main picture will appear on the right.

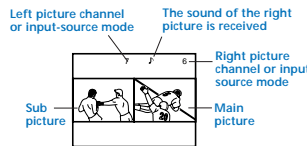

REFER TO THE ILLUSTRATION OF THE REMOTE CONTROL ON THE INSIDE FRONT COVER OF THIS MANUAL AS YOU REVIEW THIS CHART

Using the Yellow Labeled Buttons for PIP Operations	
Some control buttons for PIP and P&P are located under the cover on the top of the remote control.	
	Press to display a window picture (PIP). Each time you press, the picture size will change (1/4 → 1/9 → 1/16). Press OFF to remove the window picture.
	Press to display right (main) and left pictures (P&P). Press OFF to cancel.
	Press repeatedly to step through available video inputs: TV, VIDEO 1, VIDEO 2, VIDEO 3 and VIDEO 4. PIP will display the video source in the window picture. P&P will display the video source in the left picture. If you label one of your VIDEO inputs as SKIP, this video input will be skipped. (see "VIDEO LABEL" on page 27)
	Press to alternate sound between the main picture and the window picture for PIP and the right and left picture for P&P. A ♪ will appear for a few seconds to indicate which picture is receiving sound.

17

### Using your New TV (continued)

Using the White Labeled Buttons for TV Operations	
	Press repeatedly to step through available displays: Status Channel number, current time, channel caption (if set), and MTS mode (if SAP is selected) are displayed. SAP indication disappears after three seconds. Caption Vision/XDS Closed captioning or XDS will be displayed on the screen if the broadcaster offers these services. (see right) To cancel the display, press DISPLAY repeatedly until DISPLAY OFF appears.
	Press repeatedly to step through available video inputs: TV, VIDEO 1, VIDEO 2, VIDEO 3 and VIDEO 4 If you select SKIP as a VIDEO LABEL in the SET UP menu, your TV will skip the video input you selected. (see "VIDEO LABEL" on page 27)
	Press to change between the VHF/UHF input and the AUX input. (For detailed connection information, see "Cable box and cable" on page 4 or "Cable and antenna" on page 3) Press to change from VIDEO input to TV input.
	Press to cycle through the Multi-channel TV Sound (MTS) options: STEREO, SAP, MONO (see "MTS" on page 24) Guide is a feature of DBS, refer to your DBS operating instructions.
	Press to turn off the TV and all other equipment connected with S-Link. (see page 12)
	Press when you are finished using a VCR and you want to switch to the TV input. Your VCR power will remain on.
	Press to select an audio option. (see "EFFECT" on page 24) Options: TRUSURROUND Dolby Virtual SIMULATED EFFECT OFF TV/DBS is a feature of DBS, refer to your DBS operating instructions.

16

### CAPTION VISION

(Closed Caption)

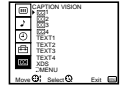

CAPTION VISION can be used for programs that are broadcast with closed caption. To access CAPTION VISION:

- 1 Press MENU.
- 2 Use the ⏪ to scroll to
- 3 Select with the ⏩ button.
- 4 Choose a CAPTION VISION option.
- 5 Access CAPTION VISION/TEXT/XDS through your DISPLAY button. (see left)

**CC1, 2, 3 or 4** Shows you a printed version of the dialog or sound effects of a program. (The mode should be set to CC1 for most programs)

**TEXT1, 2, 3 or 4** Shows you network/station information presented using either half or the whole screen.

**XDS (Extended Data Service)** Shows a network name, program name, program length, and time of the show if the broadcaster offers this service.

**Note**

- Poor reception of TV programs can cause errors in CAPTION VISION and XDS. Captions may appear with a white box or other errors instead of intended text.

### Using your New TV (continued)

Using the Yellow Labeled Buttons for PIP Operations	
	Press to change the TV channel in the secondary picture. For PIP, the channel in the window picture will change. For P&P, the channel in the left picture will change.
	Press to move the location of the window picture around the main picture. This function works only for PIP.
	Great for copying down phone numbers, addresses, recipes, etc. For PIP: Press to freeze the main picture and remove the window picture. Press  or FREEZE to resume PIP viewing. Press OFF to cancel and resume normal TV viewing. For P&P: Press to freeze both pictures. Press again to resume P&P viewing or press OFF to cancel and resume normal TV viewing.
	Press to switch the audio and video of the main picture and the window picture for PIP, or between the left and right pictures for P&P.
	Press to access CHANNEL INDEX for direct channel selection. (see "Using CHANNEL INDEX" on page 19)
	Press to cancel PIP or P&P functions and return to normal viewing.

18

### Notes

- The channel being received through the AUX jack cannot be displayed as a window picture.
- If one of the pictures received through PIP/P&P is snowy, the entire screen may appear snowy. In this case, skip the snowy channel. (see "CHANNEL SKIP / ADD" on page 26)



## Using your New TV (continued)

Using the Yellow Labeled Buttons for CHANNEL INDEX Operations	
	Press to access CHANNEL INDEX. Press again to access the next twelve receivable channels.
	Press to cycle through the receivable channels one at a time.
	Press to cancel the current operation and return to normal TV viewing.
	Press to freeze the center picture. Press again to cancel the frozen picture and resume normal center picture viewing.
Using the White Labeled Buttons for Center Picture Operations	
	Press to cycle the center picture through the video inputs. The surrounding channels will not change.
	Press to replace the center picture with a channel received through the AUX input. Press again to return to CATV input.
	Press to select the channel for the center picture. (see "Watching the TV" on pages 15-16)

REFER TO THE ILLUSTRATION OF THE REMOTE CONTROL ON THE INSIDE FRONT COVER OF THIS MANUAL AS YOU REVIEW THIS CHART

20

## Using your Menus (continued)

### Quick start to the menus

The following is a guide to your menus. For detailed information on using the remote control to modify menu settings, refer to "Learning menu selection" on page 21.

#### To select a menu:

Display → Highlight → Select



	The VIDEO menu allows you to make adjustments to your picture settings. It also allows you to customize the picture MODE based on the type of program you are watching.
	The AUDIO menu offers enhanced audio options such as listening to second audio programming (SAP), or customizing the EFFECT of the sound on your TV.
	The TIMER menu sets the clock on your TV and allows you to program your TV for scheduled viewing using the ON/OFF TIMER.
	The SET UP menu provides several options for setting up your channels, labeling your TV/VIDEO inputs, and selecting the LANGUAGE of your menus.  The CHANNEL SET UP menu is a sub-menu which provides further options for setting up your TV.

22

## Using your Menus

### Learning Menu Selection

Use the MENU button to access a menu and use the joystick to alter settings. Use the following example, in which we activate the CABLE, to learn how to modify settings.

- 1 Press the MENU button. The main menu appears.



- 2 Press up or down on the joystick to highlight the desired menu and press to activate it.

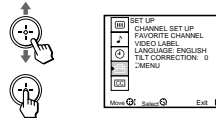

- 3 Press up or down on the joystick until the cursor points to the desired option.

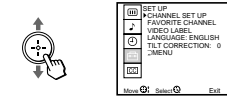

- 4 Press . Options for your selection will be displayed.



- 5 Press up or down on the joystick to make your selection and press to activate it.

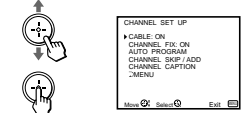

When you are done with changes to the selected menu, choose MENU to return to the main menu.



#### Notes

- Pressing MENU on the remote control will allow you to exit from the menus at any time.
- If any menu items are "grayed out" press the ANT button on your remote control until a channel number appears.

21

### Using the VIDEO Menu

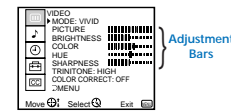

For detailed information on using the remote control to modify menu settings, refer to "Learning Menu Selection" on page 21.

#### To select the VIDEO menu:

Display → Highlight → Select



#### To restore the factory VIDEO settings

Press RESET on the remote control while the VIDEO menu is selected.

<b>MODE</b> <i>Customized picture viewing</i>	<b>VIVID:</b> Select for enhanced picture contrast and sharpness. <b>STANDARD:</b> Select to display a standard picture. <b>MOVIE:</b> Select to display a softer picture. <b>SPORTS:</b> Select to display a bright picture. You can alter the VIDEO menu settings (e.g., PICTURE, HUE) for each MODE. Select each MODE individually and then press RESET to restore factory settings.
<b>PICTURE</b> <i>Picture contrast</i>	Adjust right to increase picture contrast and create more vivid color. Adjust left to decrease picture contrast and soften the color.
<b>BRIGHTNESS</b> <i>Picture adjustment</i>	Adjust right to brighten the picture. Adjust left to darken the picture.
<b>COLOR</b> <i>Color saturation</i>	Adjust right to increase color intensity. Adjust left to decrease color intensity.
<b>HUE</b> <i>Color tones</i>	Adjust right to increase the green tones. Adjust left to decrease the green tones.
<b>SHARPNESS</b> <i>Picture detail</i>	Adjust right to sharpen the picture. Adjust left to soften the picture.
<b>TRINITONE</b> <i>White intensity adjustment</i>	<b>HIGH:</b> Select to give the white colors a blue tint. <b>MEDIUM:</b> Select to give the white colors a neutral tint. <b>NTSC STD:</b> Select to give the white colors a red tint.
<b>COLOR CORRECT</b> <i>Color ratio adjustment</i>	Select <b>ON</b> to emphasize reds and blues. Select <b>OFF</b> to emphasize greens.

23

## Using your Menus (continued)

### Using the AUDIO Menu

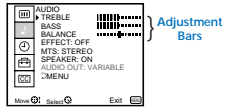

Adjustment Bars

For detailed information on using the remote control to modify menu settings, refer to "Learning Menu Selection" on page 21.

To select the AUDIO menu: Display → Highlight → Select



### To restore the factory AUDIO settings

Press RESET on the remote control while the AUDIO menu is selected.

#### Tip

Press for quick access to TRUSURROUND DOLBY VIRTUAL.

<b>TREBLE</b>	Adjust left or right to decrease or increase higher pitched sound.
<b>BASS</b>	Adjust left or right to decrease or increase low pitched sounds.
<b>BALANCE</b>	Adjust left or right to emphasize left or right speaker volume.
<b>EFFECT</b> <i>Customize sound effect based on the program's audio type</i>	<b>TRUSURROUND:</b> Produces a virtual surround effect for Dolby-surround encoded programs. <b>SIMULATED:</b> Adds a surround-like effect to mono programs. <b>OFF:</b> Normal stereo or mono reception.
<b>MTS</b> <i>Enjoy stereo, bilingual and mono programs</i>	<b>MTS:</b> Press  or  to select one of the following options: <b>STEREO:</b> Select when viewing a broadcast in stereo. <b>SAP:</b> Select to listen to bilingual broadcast. (Non-SAP programs will be muted when this feature is selected) <b>MONO:</b> Select to reduce noise during stereo broadcasts for areas of weak reception. <b>Quick MTS access:</b> Press MTS on your remote control to cycle through the MTS options.
<b>SPEAKER</b> <i>Custom selection of audio output source</i>	<b>ON:</b> Select to listen to the sound from the TV speakers alone or the TV speakers and a separate stereo system. <b>OFF:</b> Select to turn off the TV speakers and listen to the TV's sound only through external audio system speakers.
<b>AUDIO OUT</b> <i>Easy control of volume adjustments</i>	<b>AUDIO OUT</b> can only be set when SPEAKER is set to OFF. <b>VARIABLE:</b> Sound output varies according to the TV settings. <i>Useful when you want to use your remote control to control the output of a separate audio system.</i> <b>FIXED:</b> Sound output is held at a fixed level through your stereo. <i>Use your A/V receiver's remote control to adjust the volume.</i>

### Using the TIMER Menu

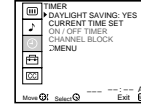

After setting the clock you can use the timer to turn the TV on and off.

For detailed information on using the remote control to modify menu settings, refer to "Learning Menu Selection" on page 21.

### To select the TIMER menu:

Display → Highlight → Select

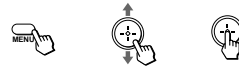

#### Tip

Set DAYLIGHT SAVING time before setting the clock. Any loss of power will cause these settings to be erased.

<b>DAYLIGHT SAVING</b> <i>Automatically adjusts the time</i>	<b>Spring:</b> Select YES to compensate for Daylight Saving Time. The current time automatically moves ahead one hour. <b>Fall:</b> Select NO at the end of Daylight Saving Time. The current time moves back one hour.	
<b>CURRENT TIME SET</b> <i>Necessary for the ON/OFF TIMER</i>	1 Press , then press up or down on the joystick until the current day is displayed, and press . 2 Press up or down on the joystick until the current hour and AM/PM is displayed, and press . 3 Press up or down on the joystick until the current minute is displayed, and press . The clock is set. Press MENU to exit.	
<b>ON/OFF TIMER</b> <i>Wake up or scheduled viewing</i>	1 Select a timer (1 or 2). 2 Press up or down on the joystick until the desired day or range of days is displayed, and press . 3 Press up or down on the joystick until the time (hours and minutes) that you want the TV to remain on is displayed, and press . 4 Press up or down on the joystick to set the time duration (maximum of 6 hours) and press . <b>TO CANCEL THE TIMER FUNCTION, PRESS RESET WHILE THE ON/OFF TIMER MENU IS DISPLAYED.</b> 5 Press up or down on the joystick to select the desired channel and press . The timer is now set. The TIMER indicator on your TV will be lit. Press MENU to exit. Performing AUTO PROGRAM will erase all TIMER settings.	
<b>CHANNEL BLOCK</b> <i>Prevent access to certain channels</i>	You will be able to block two channels for a period of up to 12 hours. <b>FOLLOW STEPS 1-5 OF ON/OFF TIMER ABOVE</b> To erase your CHANNEL BLOCK settings, press RESET while in the CHANNEL BLOCK window. Performing AUTO PROGRAM will erase your CHANNEL BLOCK settings.	

## Using your Menus (continued)

### Using the SET UP Menu



<b>CHANNEL SET UP</b> <i>Basic set up options for viewing</i>	With the CHANNEL SET UP menu open: 1 Use the joystick to select the feature you want to change. 2 Press  to access the feature. <b>CABLE:</b> Select ON if your TV is connected to a cable system. (Easy Setup Guide will set CABLE to OFF automatically if a cable channel is not available) <b>CHANNEL FIX:</b> Press up or down on the joystick to set the TV's input to one of the following options: 2-6: When the cable box is connected to the VHF/UHF input and you do not want to switch to AUX mode. Press DBS/CABLE (FUNCTION) and then CH +/- to change channels. <b>AUX 2-6:</b> When a cable box is connected to AUX and a cable or antenna is connected to VHF/UHF. You can alternate between the two inputs by pressing ANT. <b>VIDEO 1:</b> When you have connected video equipment (e.g. A/V receiver) and you want the TV input fixed to it. You will be able to alternate between video sources. <b>OFF:</b> When you want to switch CHANNEL FIX off. If the TV is in the AUX mode when you turn CHANNEL FIX off, press ANT to return to regular (CATV) mode. <b>TIMER and CHANNEL BLOCK settings are erased when CHANNEL FIX is set.</b> <b>AUTO PROGRAM:</b> Allows the TV to program all receivable channels. <b>CHANNEL SKIP/ADD:</b> With the CHANNEL SKIP/ADD window open:  1 Press  to SKIP or ADD (only one option will be available). 2 Select the desired channel.	
<b>CHANNEL CAPTION</b>	<b>CHANNEL CAPTION:</b> Label up to 12 channels, with up to four letters each. With the CHANNEL CAPTION window open:  1 Press  and then press up or down on the joystick to select the desired channel, and press  again. 2 Press up or down on the joystick to display the first letter or number of the caption and press  to select it. 3 Press . To erase a Caption, press RESET.	

For detailed information on using the remote control to modify menu settings, refer to "Learning Menu Selection" on page 21.

### To select the SET UP menu:

Display → Highlight → Select



If any menu items are "grayed out", press the ANT button on your remote control so that a channel number appears.

#### Notes

- Your remote control can be programmed to operate your cable box. (see page 33)
- After setting CABLE, you will need to run AUTO PROGRAM.
- ON/OFF TIMER and CHANNEL BLOCK settings will be erased when CHANNEL FIX is set.

<b>FAVORITE CHANNEL</b> <i>User's favorite channels</i>	The FAVORITE CHANNEL feature provides a multi-picture presentation to enable direct channel selection. (for details on how to set up this feature, see "Setting and Selecting FAVORITE CHANNEL" on page 28) The FAVORITE CHANNEL feature is not available for the AUX input.	
<b>VIDEO LABEL</b> <i>Label connected equipment for easy recognition (e.g. DBS, VHS, etc.)</i>	With the VIDEO LABEL menu open: 1 Press up or down on the joystick to select the input mode you want to label and press . 2 Press up or down on the joystick to select the label and press . <b>VIDEO LABEL Options:</b> VIDEO 1/2/3: VHS, 8mm, BETA, LD, GAME, DBS, DVD, WEB, RECEIVER, DTV, SKIP VIDEO 4: DVD, DTV, SKIP <i>If you select SKIP, your TV will skip this connection when you scan through video sources using the TV/VIDEO button. When VIDEO LABEL is set to WEB, the screen will darken, creating an ideal picture for WebTV viewing.</i>	
<b>LANGUAGE</b> <i>User's preferred language</i>	Select from available languages to display all menus in your language of choice.	
<b>TILT CORRECTION</b> <i>Adjust your picture</i>	Use this feature to correct any tilt of the picture. Press up or down on the joystick to select a correction between +5 and -5 and press .	

## Using your Menus (continued)

### Setting and Selecting FAVORITE CHANNEL

The FAVORITE CHANNEL feature provides a multi-picture presentation to enable direct channel selection.

Your FAVORITE CHANNEL options can be set automatically or manually.

The factory setting for FAVORITE CHANNEL is AUTO. When FAVORITE CHANNEL is set to AUTO, the last eight channels selected with the 0-9 buttons will be set as FAVORITE CHANNEL options.

#### Setting FAVORITE CHANNEL manually

1 Select FAVORITE CHANNEL from the SET UP menu.

The FAVORITE CHANNEL menu will appear. If you set CHANNEL CAPTION, captions (e.g. CNN, HBO) for the channels selected will display. (see "CHANNEL CAPTION" on page 26)

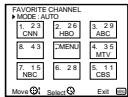

2 Select MODE and press  $\oplus$ .

Press up or down on the joystick to display MANUAL and press  $\oplus$ .

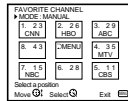

3 Press down on the joystick to select 1 and press  $\oplus$ .

Press up or down on the joystick to select a channel and press  $\oplus$ .

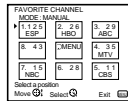

You have now selected a favorite channel for position 1.

4 Use the joystick to select other FAVORITE CHANNEL positions and program other favorite channels.

5 Press MENU when you are finished.

Your favorite channels are now ready to use.

#### Resetting FAVORITE CHANNEL choices

You have the option of returning to the FAVORITE CHANNEL screen to adjust any of your favorite channel choices. Simply proceed as described in "Setting FAVORITE CHANNEL manually" (skip step 2 if MANUAL is already selected). When you reach step 3, select the position you want to change and press  $\oplus$ . Press RESET to clear the channel for that position.

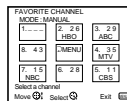

Press up or down on the joystick to select a new channel and press  $\oplus$ . Press MENU when you are done.

#### Note

- Channels received through the VHF/UHF input and the AUX input cannot be viewed within the FAVORITE CHANNEL menu at the same time.

### Using FAVORITE CHANNEL

You can use the FAVORITE CHANNEL feature to display multiple channels for direct selection.

1 Press  $\oplus$  once.

The current channel will be displayed in the center of the screen surrounded by your eight favorite channels.



A yellow frame will appear to indicate current channel selection. The TV will continually update each of the surrounding pictures.

2 When you find a channel that you wish to view, use the joystick to move the yellow frame to that picture.

The sound of the picture surrounded by the yellow frame will be heard.



3 Press  $\oplus$  to select the channel.

The selected channel will be retrieved and displayed for normal viewing.



#### Notes

- You cannot move the yellow frame until all of the surrounding pictures appear.
- If one of the pictures received through FAVORITE CHANNEL is snowy, the entire screen may appear snowy. In this case, erase the snowy channel using CHANNEL SKIP/ADD. (see "CHANNEL SET UP" on page 26)

## Using your Menus (continued)

### Setting and Selecting FAVORITE CHANNEL (continued)

#### Using the Yellow Labeled Buttons for FAVORITE CHANNEL Operations

Some control buttons are located under the cover on the top of the remote control.

	Press to freeze the center picture. Press again to cancel the frozen picture and resume normal FAVORITE CHANNEL viewing.
	Press to cancel the current operation and return to normal TV viewing.
<b>Using the White Labeled Buttons for Center Picture Operations</b>	
	Press to cycle the center picture through the video inputs. The surrounding channels will not change.
	Press to replace the center picture with a channel received through the AUX input. Press again to return to CATV input.
or  or	Press to select the channel for the center picture. (see "Watching the TV" on pages 15-16)



REFER TO THE ILLUSTRATION OF THE REMOTE CONTROL ON THE INSIDE FRONT COVER OF THIS MANUAL AS YOU REVIEW THIS CHART

## Operating Video Equipment

### Setting the Manufacturer's Code

You can use the supplied remote control to operate Sony or non-Sony video equipment that has an infrared sensor.

1 Set the VTR 1/2/3/DVD/MDP switch to the position through which you would like to access the video equipment.

The following Sony equipment is preset to each position of the switch:

VTR1 (303) Beta, ED Beta VCRs  
VTR2 (302) 8 mm VCR  
VTR3 (301) VHS VCR  
DVD/MDP (751) DVD Player

2 Press CODE SET, VTR/DVD (FUNCTION), the 0-9 buttons to enter the manufacturer's code number (see the following chart), then press ENTER.

For example, to operate a Sony 8mm VCR:

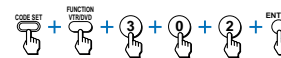

If the remote control doesn't work

- Try repeating the set up procedures using the other codes listed for your equipment.

### VCR code numbers

Manufacturer	Code	
Sony	301, 302, 303	Multitech 325, 338, 321
Aiwa	338, 344	NEC 314, 336, 337
Admiral (M. Ward)	327	Olympic 309, 308
Audio Dynamic	314, 337	Optimus 327
Bell & Howell (M. Ward)	330, 343	Panasonic 308, 309, 306, 307
Broksonic	319, 317	Pentax 305, 304
Canon	309, 308	Philco 308, 309
Citizen	332	Philips 308, 309, 310
Craig	315, 302, 332	Pioneer 308
Criterion	315	Quasar 308, 309, 306
Curtis Mathes	304, 338, 309	RCA/PROSCAN 304, 305, 308, 309, 311, 329, 312, 313, 310
Daewoo	341, 312, 309	Realistic 309, 330, 328, 335, 324, 338
DBX	314, 336, 337	Sansui 314
Dimensia	304	Singer 315
Emerson	319, 320, 316, 317, 318, 341	Samsung 322, 313, 321
Fisher	330, 334, 335, 333	Sanyo 330, 335
Funai	338	Scott 312, 313, 321, 335, 323, 324, 325, 326
General Electric	329, 304, 309	Sharp 327, 328
Go Video	322	Shintom 315
Goldstar	332	Signature 2000 (M. Ward) 338, 327
Hitachi	306, 304, 305, 338	Sylvania 308, 309, 338, 310
Instant Replay	309, 308	Symphonic 338
JC Penney	309, 305, 304, 330, 314, 336, 337	SY2000 338
JVC	314, 336, 337, 345, 346, 347	Tashiro 332
Kenwood	314, 336, 332, 337	Tatung 314, 336, 337
LXI (Sears)	332, 305, 333, 334, 330, 335, 338	Teac 314, 336, 338, 337
Magnavox	308, 309, 310	Technics 309, 308
Marantz	314, 336, 337	Toshiba 312, 311
Marta	332	Wards 327, 328, 335, 331, 332
Memorex	309, 335	XR-1000 315
Minoita	305, 304	Yamaha 330, 314, 336, 337
Mitsubishi/MGA	323, 324, 325, 326	Zenith 331

## Operating Video Equipment (continued)

### MDP code numbers

Manufacturer	Code
Sony	701
Panasonic	704, 710
Pioneer	702

### DVD Player code numbers

Manufacturer	Code
Sony	751
Panasonic	753
Pioneer	752
RCA	755
Toshiba	754

#### Tips

- In some rare cases, you may not be able to operate your non-Sony video equipment with the supplied remote control. In this case, please use the equipment's own remote control.
- When you remove the batteries, the code number may revert to the factory setting.

### To operate video equipment

- Set the VTR1/2/3/DVD/MDP switch to the position through which you would like to access the video equipment.
- Use the VCR/DVD/MDP buttons indicated in the following tables.

32

### Operating a VCR using the remote control

To turn On/Off	Press VTR/DVD (POWER). [Green Button]
To select a channel	Press the 0-9 buttons.
To change channels	Press CH +/-.
To record	Press (REC) while pressing (upper left).
To play	Press ▶.
To stop	Press ■.
To fast forward	Press ►►.
To rewind the tape	Press ◀◀.
To pause	Press II. Press again to resume normal playback.
To scan the picture	Press ►► or ◀◀ during playback. Release to resume normal playback.
To change input mode	Press TV/VTR.

### Operating an MDP using the remote control

To turn On/Off	Press VTR/DVD (POWER). [Green Button]
To play	Press ▶.
To stop	Press ■.
To pause	Press II. Press again to resume normal playback.

To scan the picture	Press ►► or ◀◀ during playback. Release to resume normal playback.
To search a chapter forward or backward	Press CH +/-.

### Operating a DVD Player using the remote control

To turn On/Off	Press VTR/DVD (POWER). [Green Button]
To play	Press ▶.
To stop	Press ■.
To pause	Press II. Press again to resume normal playback.
To step through different tracks of an audio disc	Press ►► to step forward or ◀◀ to step backward.
To step through different chapters of a video disc	Press CH+ to step forward or CH- to step backward.
To display the Title menu	Press TITLE.
To display the DVD software menu	Press DVD MENU.
To select tracks directly	Press 0-9 buttons and ENTER.
To display the menu (Set up)	Press MENU.
To move the cursor in the menu	Move the joystick in the corresponding direction.

## Operating a Cable Box or DBS Receiver

### Setting the Manufacturer's Code

You can program the supplied remote control to operate a cable box or DBS receiver.

Press CODE SET, DBS/CABLE (FUNCTION), the 0-9 buttons to enter the manufacturer's code number (see the following chart), then press ENTER.

For example, to operate a Sony DBS receiver:



### Cable box code numbers

Manufacturer	Code
Hamlin/Regal	222, 223, 224, 225, 226
Jerrold/G. I.	201, 202, 203, 204, 205, 206, 207, 208, 218
Oak	227, 228, 229
Panasonic	219, 220, 221
Pioneer	214, 215
Scientific Atlanta	209, 210, 211
Tocom	216, 217
Zenith	212, 213

### DBS receiver code numbers

Manufacturer	Code number
Sony	801 (preset code for remote control)
General Electric	802
Hitachi	805
Hughes	804
Panasonic	803
RCA/PROSCAN	802, 808
Toshiba	806, 807

### To operate the TV

Press TV (FUNCTION). Then use the TV control buttons to control the TV.

### For more details on operating the cable box or DBS receiver

Refer to the operating instructions supplied with the equipment.

### If the remote control doesn't work

- First, try repeating the set up procedures using the other codes listed for your equipment.

#### Tips

- If more than one code number is listed, try entering them one by one until you come to the correct code for your equipment.
- If you enter a new code number, the code number you previously entered at that setting is erased.
- In some rare cases, you may not be able to operate your equipment with the supplied remote control. In this case, use the equipment's supplied remote control.
- Whenever you remove the batteries — to replace them, for example — if too much time is taken, the code numbers may revert to the factory setting.

33

## Troubleshooting

<b>To reset the TV to factory settings</b>	<ul style="list-style-type: none"> <li>First, turn the TV on. Then, while pressing the RESET button on the remote control, press the POWER button on the TV. The TV will turn itself off, then back on. When the TV turns on again, all settings will be reset, and the Easy Setup Guide will appear.</li> </ul>
<b>No picture (screen not lit), no sound</b>	<ul style="list-style-type: none"> <li>If your TV does not turn on, and a red light keeps flashing, your TV may need service. Call your local Sony service center.</li> <li>Make sure the power cord is plugged in.</li> <li>Operate with the buttons on the TV and the remote control.</li> <li>Check to see if the TV/VIDEO setting is correct: when watching TV, set to TV, and when watching video tapes, set to VIDEO 1, 2, 3 or 4.</li> <li>Try another channel. It could be station trouble.</li> <li>Perform Easy Setup Guide again using the SET UP button to return to the factory preset condition. (see "To perform AUTO SET UP again" on page 14)</li> </ul>
<b>Remote control does not operate</b>	<ul style="list-style-type: none"> <li>Batteries could be weak. Replace the batteries.</li> <li>Press TV (FUNCTION) when operating your TV.</li> <li>Make sure the TV's power cord is connected securely to the wall outlet.</li> <li>Locate the TV at least 3-4 feet away from fluorescent lights.</li> <li>Check the S-Link connection. (see page 12)</li> <li>Make sure the batteries are inserted correctly.</li> </ul>
<b>Dark, poor or no picture (screen lit), good sound</b>	<ul style="list-style-type: none"> <li>Adjust PICTURE in the VIDEO menu. (see "PICTURE" on page 23)</li> <li>Adjust BRIGHTNESS in the VIDEO menu. (see "BRIGHTNESS" on page 23)</li> <li>Check antenna/cable connections.</li> <li>Perform Easy Setup Guide again using the SET UP button to return to the factory preset condition. (see "To perform AUTO SET UP again" on page 14)</li> <li>When VIDEO LABEL is set to WEB, the screen will darken, creating an ideal picture for WebTV viewing. (see "VIDEO LABEL" on page 28)</li> </ul>
<b>Good picture, no sound</b>	<ul style="list-style-type: none"> <li>Press MUTING so that "MUTING" disappears from the screen. (see "MUTING" on page 16)</li> <li>Check the MTS setting in the AUDIO menu. (see "MTS" on page 24)</li> <li>Make sure SPEAKER is set to ON in the AUDIO menu. (see "SPEAKER" on page 24)</li> <li>Perform Easy Setup Guide again using the SET UP button to return to the factory preset condition. (see "To perform AUTO SET UP again" on page 14)</li> </ul>
<b>Cannot receive upper channels (UHF) when using an antenna</b>	<ul style="list-style-type: none"> <li>Make sure CABLE is OFF in the SET UP menu. (see "CHANNEL SET UP" on page 26)</li> <li>Use AUTO PROGRAM to add receivable channels that are not presently in TV memory. (see "CHANNEL SET UP" on page 26)</li> </ul>
<b>No color</b>	<ul style="list-style-type: none"> <li>Adjust the COLOR in the VIDEO menu. (see "COLOR" on page 23)</li> <li>Perform Easy Setup Guide again using the SET UP button to return to the factory preset condition. (see "To perform AUTO SET UP again" on page 14)</li> </ul>

34

<b>Only snow and noise appear on the screen</b>	<ul style="list-style-type: none"> <li>Check the CABLE setting in the SET UP menu. (see "CHANNEL SET UP" on page 26)</li> <li>Check the antenna/cable connections.</li> <li>Make sure the channel is broadcasting programs.</li> <li>Press ANT to change the input mode. (see "ANT" on page 16)</li> </ul>
<b>Dotted lines or stripes</b>	<ul style="list-style-type: none"> <li>Adjust the antenna.</li> <li>Move the TV away from noise sources such as cars, neon signs, or hair-dryers.</li> </ul>
<b>TV is fixed to one channel</b>	<ul style="list-style-type: none"> <li>Try turning CHANNEL FIX off. (see "CHANNEL SET UP" on page 26)</li> <li>Use AUTO PROGRAM to add receivable channels that are not presently in the TV memory. (see "CHANNEL SET UP" on page 26)</li> </ul>
<b>Double images or ghosts</b>	<ul style="list-style-type: none"> <li>Use a highly directional outdoor antenna or a cable (when the problem is caused by reflections from nearby mountains or tall buildings).</li> </ul>
<b>Cannot operate menu</b>	<ul style="list-style-type: none"> <li>If the item you want to choose appears in gray, you cannot select it. Your TV may be receiving video input. Try pressing TV/VIDEO.</li> </ul>
<b>Cannot receive any channels when using cable tv</b>	<ul style="list-style-type: none"> <li>Make sure CABLE is ON in the SET UP menu. (see "CHANNEL SET UP" on page 26)</li> <li>Use AUTO PROGRAM to add receivable channels that are not presently in TV memory. (see "CHANNEL SET UP" on page 26)</li> </ul>
<b>Cannot gain enough volume when using a cable box</b>	<ul style="list-style-type: none"> <li>Increase the volume at the cable box. Then press TV (FUNCTION) and adjust the TV's volume.</li> </ul>
<b>TV malfunctions when using the S-Link function</b>	<ul style="list-style-type: none"> <li>Check the S-Link connection. (see on page 12)</li> </ul>
<b>CHANNEL INDEX does not display all available channels</b>	<ul style="list-style-type: none"> <li>Make sure CABLE is ON in the SET UP menu. (see "CHANNEL SET UP" on page 26)</li> <li>Use AUTO PROGRAM to add receivable channels that are not presently in the TV memory. (see "CHANNEL SET UP" on page 26)</li> </ul>
<b>FAVORITE CHANNEL does not display your choices</b>	<ul style="list-style-type: none"> <li>Verify that MODE is set to MANUAL in the FAVORITE CHANNEL menu. (see "Setting FAVORITE CHANNEL manually" on page 28)</li> </ul>
<b>Some video sources do not appear when you press TV/VIDEO</b>	<ul style="list-style-type: none"> <li>Ensure that VIDEO LABEL is not set to SKIP. (see "VIDEO LABEL" on page 27)</li> </ul>
<b>Recording through MONITOR OUT does not function properly when recording in PIP or P&amp;P mode</b>	<ul style="list-style-type: none"> <li>MONITOR OUT will not record both images in PIP or P&amp;P. Only the main picture will be recorded.</li> <li>If you are recording the main picture and you switch to the sound of the sub picture using the AUDIO button, the main picture will be recorded with sound from the other program.</li> </ul>

If, after reading these operating instructions, you have any additional questions related to the use of your Sony television, please call our Direct Response Center at 1-800-222-SONY (7669) (customers in the U.S. only) or (416) 499-SONY (7669) (customers in Canada only).

35

## SECTION 2 DISASSEMBLY

### 2-1. REAR COVER AND SPEAKER REMOVAL

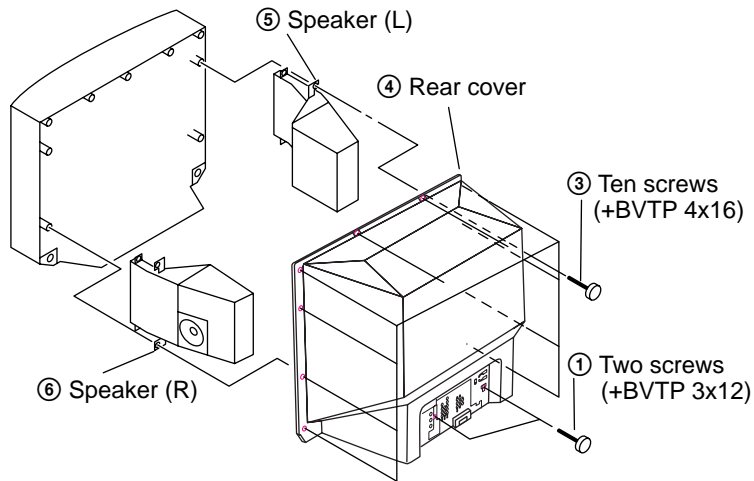

### 2-2. CHASSIS ASSY REMOVAL

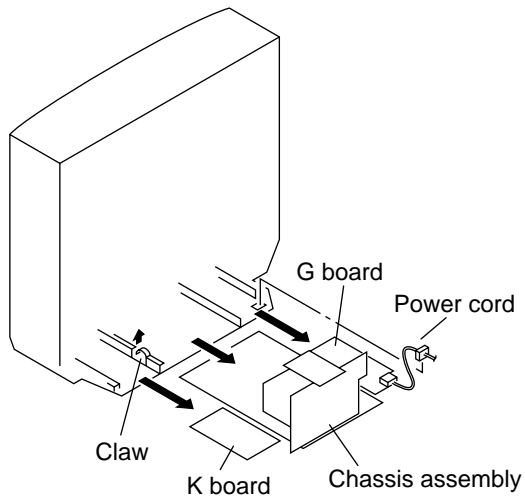

### 2-3. SERVICE POSITION

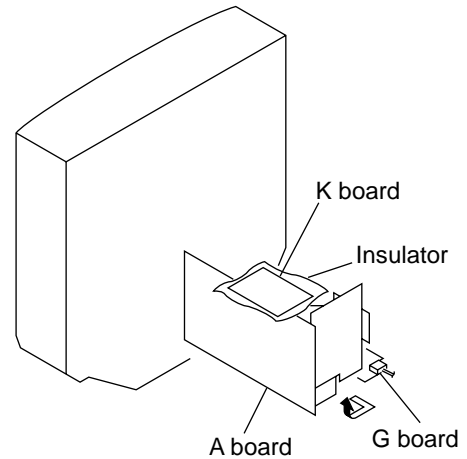

### 2-4. CONTROL ASSY REMOVAL

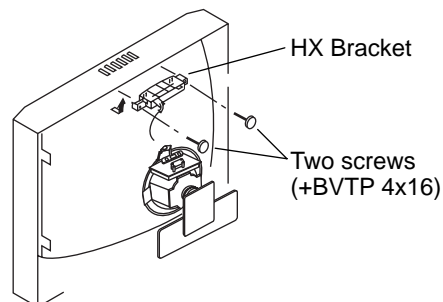

## 2-5. EXTENSION CABLE

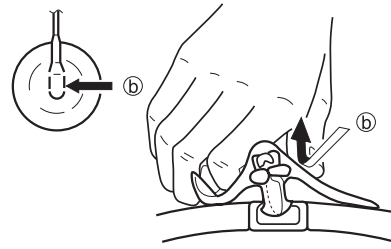
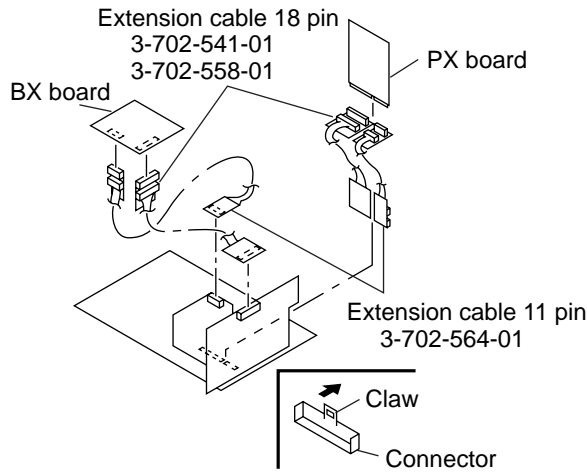

Use your thumb to pull the rubber cap firmly in the direction indicated by arrow (b).

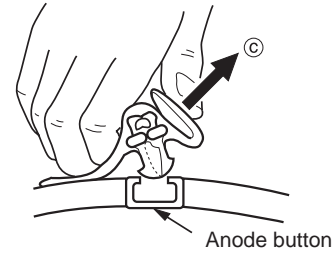

③ When one side of the rubber cap separates from the anode button, the anode-cap can be removed by turning the rubber cap and pulling it in the direction of arrow (c).

### • ANODE-CAP REMOVAL

**WARNING:** High voltage remains in the CRT even after the power is disconnected. To avoid electrical shock, discharge CRT before attempting to remove the anode cap. Short between anode and coated earth ground strap of CRT.

**NOTE:** After removing the anode, short circuit the anode of the picture tube and the anode cap to either the metal chassis, CRT shieldor carbon painted on the CRT.

### • HOW TO HANDLE AN ANODE CAP

- ① Do not use sharp objects which may cause damage to the surface of the anode-cap.
- ② Do not squeeze the rubber covering too hard to avoid damaging the anode-cap. A material fitting called a shatter-hook terminal is built into the rubber.
- ③ Do not force turn the foot of the rubber cover. This may cause the shatter-hook terminal to protrude and damage the rubber.

### • REMOVAL PROCEDURES

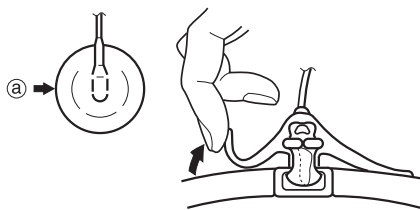

① Turn up one side of the rubber cap in the direction indicated by the arrow (a).

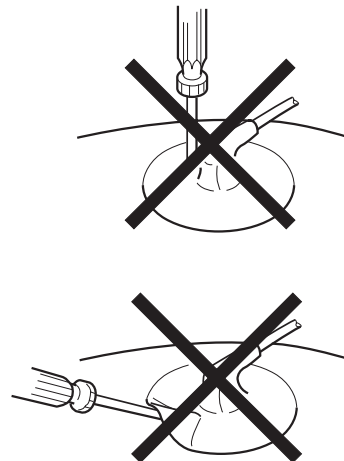

## 2-6. PICTURE TUBE REMOVAL

**WARNING** Before removing anode cap:

High voltage remains in the CRT even after the power is disconnected.

To avoid electrical shock, discharge CRT before attempting to remove the anode cap. Short between anode and coated earth ground strap of CRT.

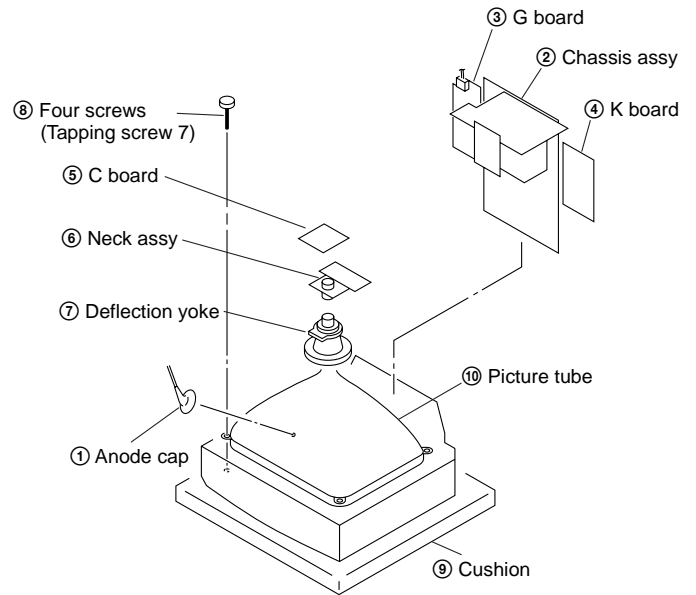
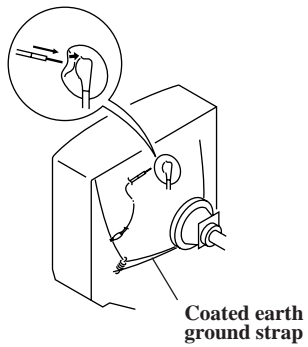

## SECTION 3 SET-UP ADJUSTMENTS

The following adjustments should be made when a complete realignment is required or a new picture tube is installed.

These adjustments should be performed with rated power supply voltage unless otherwise noted.

Set the controls and switch as follows unless otherwise noted:

VIDEO MODE: STANDARD

PICTURE control ..... 100%

BRIGHTNESS control ..... 50%

Perform the adjustments in order as follows:

1. Beam Landing
2. Convergence
3. Focus
4. Screen (G2)/White Balance

**Note:** Test Equipment Required

1. Color Bar Pattern Generator
2. Degausser
3. DC Power Supply
4. Digital Multimeter

### 3-1. BEAM LANDING

#### Preparation:

- Input a white pattern signal.
- Face the picture tube in a East or West direction to reduce the influence of geomagnetism.

NOTE: Do not use the hand degausser because it magnetizes the CRT .

1. Input white pattern from pattern generator.
2. Loosen the deflection yoke mounting screw, and set the purity control to the center as shown below:

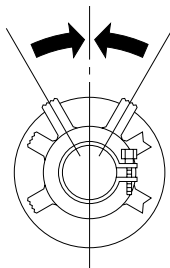

3. Input green pattern from pattern generator.
4. Move the deflection yoke backward, and adjust with the purity control so that green is in the center and red and blue are even on both sides.

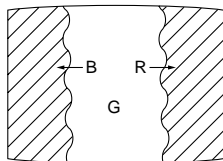

5. Move the deflection yoke forward, and adjust so that the entire screen becomes green.

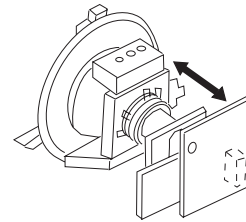

6. Switch over the raster signal to red and blue and confirm the condition.
7. When the position of the deflection yoke is determined, tighten it with the deflection yoke mounting screw.
8. When landing at the corner is not right, adjust by using the disk magnets.

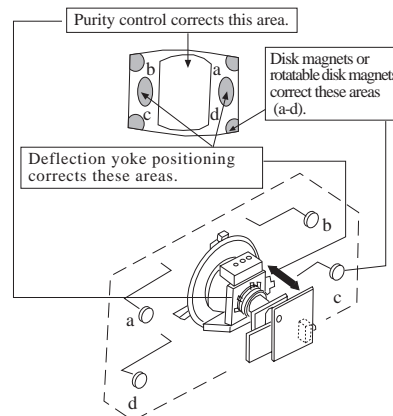



### 3-2. CONVERGENCE

#### Preparation:

- Before starting, perform FOCUS, V. LIN and V. SIZE adjustments.
- Set BRIGHTNESS control to minimum.
- Input dot pattern.

#### (1) Vertical and Horizontal Static Convergence

1. Adjust V. STAT magnet to converge red, green and blue dots in the center of the screen. (Vertical movement Adjust HSTAT RV to converge.)

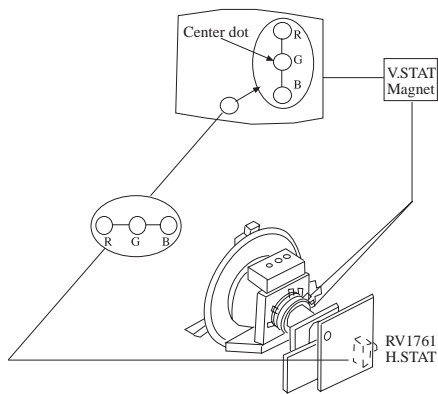

Tilt the V. STAT magnet and adjust static convergence to open or close the V. STAT magnet.

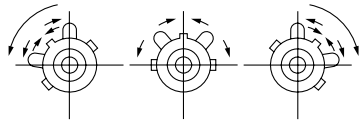

2. When the V. STAT magnet is moved in the direction of arrow (a) and (b), red, green, and blue dots move as shown below:

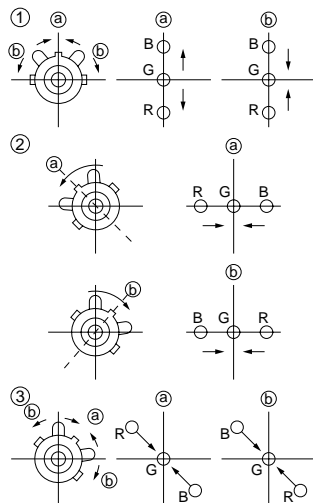

#### Operation of BMC (Hexapole) Magnet

The respective dot positions resulting from moving each magnet interact, so perform adjustment while tracking.

Use the VSTAT tabs to adjust the red, green, and blue dots so they line up at the center of the screen (move the dots in a horizontal direction.)

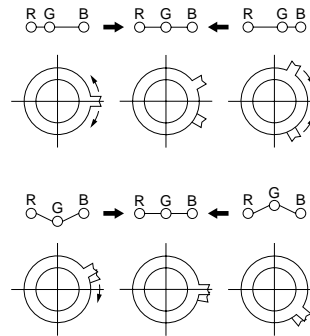

#### Y Separation Axis Correction Magnet Adjustment

1. Input cross-hatch pattern, adjust PICTURE to minimum and BRIGHTNESS to normal.
2. Adjust the deflection yoke upright so it touches the CRT.
3. Adjust so that the Y separation axis correction magnet on the neck assembly is symmetrical from top to bottom (open state).

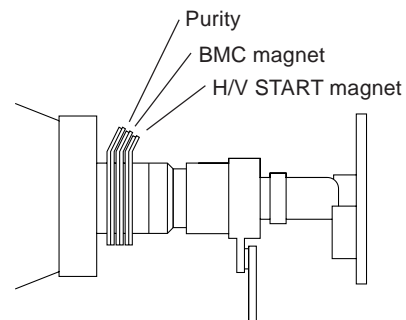

4. Return the deflection yoke to its original position.

## ( 2 ) Dynamic Convergence Adjustment

- Before starting, perform Horizontal and Vertical Static Convergence Adjustment.
1. Slightly loosen deflection yoke screw.
  2. Remove deflection yoke spacers.
  3. Move the deflection yoke for best convergence as shown below:

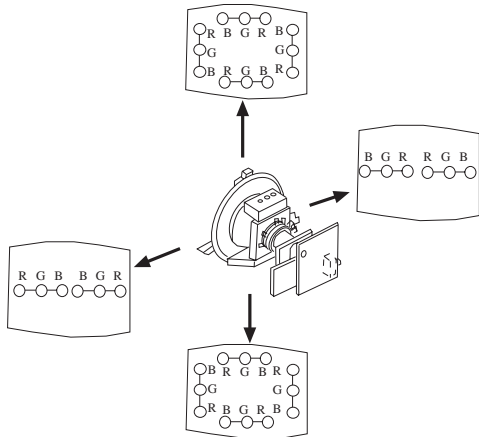

4. Tighten the deflection yoke screw.
5. Install the deflection yoke spacers.
6. Adjust vertical red and blue convergence with VLT (VR).
7. Adjust horizontal red and blue convergence with YCH (VR).

## ( 3 ) Screen-corner Convergence

Affix a permalloy assembly to correspond with the misconverged areas:

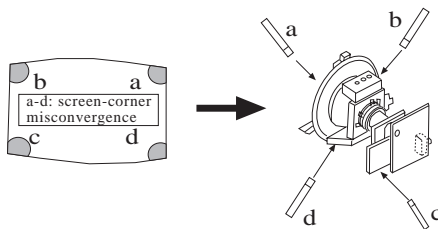

## 3-3. FOCUS

Adjust FOCUS control for best picture.

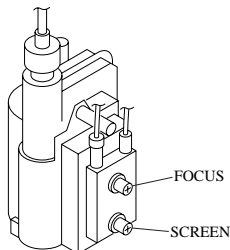

## 3-4. SCREEN (G2)

1. Input dot pattern from the pattern generator.
2. Set the PICTURE and BRIGHT controls at normal.
3. Adjust S BRT, G CUT, B CUT in service mode with an oscilloscope so that voltages on the red, green, and blue cathodes are  $170V \pm 2 V DC$ .
4. Observe the screen and adjust SCREEN (G2) VR on FBT to obtain the faintly visible background of dot signal.

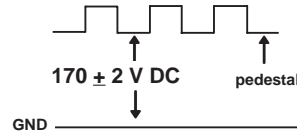

## 3-5. WHITE BALANCE ADJUSTMENTS

NO.	Disp.	Item	Average
18	GDRV	Green Drive	31
19	BDRV	Blue Drive	25
20	GCUT	Green Cut-off	3
21	BCUT	Blue Cut-off	10
29	SBRT	Sub Bright	30

1. Input an entire white signal.
2. Set to Service adjustment Mode.
3. Set the PICTURE and BRIGHT to minimum.
4. Adjust with SBRT if necessary.
5. Select GCUT and BCUT with [1] and [4] .
6. Adjust with [3] and [6] for the best white balance.
7. Set the PICTURE and BRIGHT to maximum.
8. Select GDRV and BDRV with [1] and [4] .
9. Adjust with [3] and [6] for the best white balance.
10. After adjusting the white balance, adjust the white balance video four as follows:

NO.	Disp.	Item	Calculate the Average Data
22	4GDR	Green Drive	GDRV+2
23	4BDR	Blue Drive	BDRV +1
24	4GCT	Green Cut-off	GCUT
25	4BCT	Blue Cut-off	BCUT-1

11. Write into the memory by pressing [MUTING] then [ENTER] .

## SECTION 4 SAFETY RELATED ADJUSTMENTS

### R530, R531 CONFIRMATION METHOD (HOLD-DOWN CONFIRMATION) AND READJUSTMENTS

Always perform the following adjustments when replacing the following components marked with a ■ mark on the schematic diagram:

<b>A BOARD:</b>	IC351, IC501, D519, D520, D521, C531, C532, R387, R529, R530, R531, R532, R533, R550, T503
-----------------	--

<b>G BOARD:</b>	IC643, R661
-----------------	-------------

#### Step 1 Preparation before Confirmation

Turn the POWER switch ON.

Input a white signal and set the PICTURE and BRIGHT controls to maximum.

Confirm that the voltage at the check terminal of TP85 is more than 23.0 V DC when the set is operating normally.

At AC input:  $120.0 \pm 2.0$  VAC

#### Step 2

Input a white signal and verify that I ABL is within the specified range:  $2175 \pm 100$   $\mu$ A.

At AC input:  $120.0 \pm 2.0$  VAC

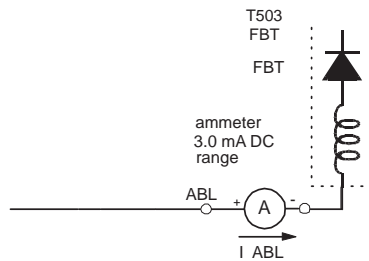

#### Step 3

Record the voltage between TP85 and ground.

#### Step 4

Using an external DC power supply, apply voltage between TP85 and ground.

Increase the voltage gradually and confirm that the hold-down works (raster disappears) at lower than the voltage recorded in Step 3.

Lower than 27.24 V DC

At AC input:  $120.0 \pm 2.0$  VAC

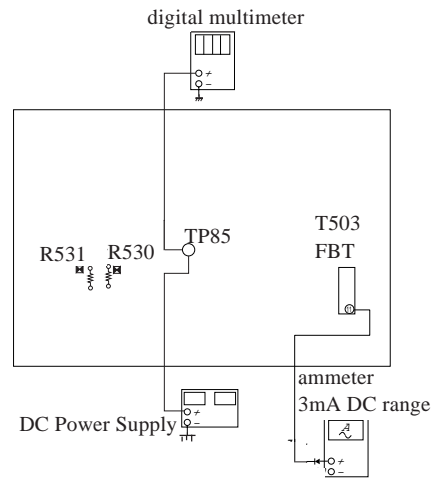

#### A BOARD - CONDUCTOR SIDE

#### Step 5

Confirm that a voltage of more than 23.0 V DC appears between TP85 and ground.

At AC input:  $120.0 \pm 2.0$  VAC

### B+ VOLTAGE CONFIRMATION AND ADJUSTMENT

Always perform the following adjustments when replacing the following components marked with ■ on the schematic diagram:

<b>G BOARD:</b> IC643, R661
-----------------------------

- 1) Using Variac, apply AC input voltage:  $130 \pm 2.0$  VAC
- 2) Input a monoscope signal.
- 3) Set the PICTURE control and the BRIGHTNESS control to initial reset value.
- 4) Confirm the voltage of G BOARD CN641 between pin ① to ground is less than  $136.5 \pm 1.0$  V DC.
- 5) If step 4 is not satisfied, replace the R661 and repeat the above steps.

## SECTION 5 CIRCUIT ADJUSTMENTS

### ELECTRICAL ADJUSTMENT BY REMOTE COMMANDER

Use Remote Commander (RM-Y144) to perform the following circuit adjustments:

NOTE : Test Equipment Required:

1. Pattern Generator
2. Frequency Counter
3. Digital Multimeter
4. Audio OSC

#### (1) Setting the Service Adjustment Mode

##### SERVICE MODE PROCEDURE

1. Standby mode. (Power off)
2. **DISPLAY** → **5** → **VOL (+)** → **POWER** on the Remote Commander. (Press each button within a second.)

##### SERVICE ADJUSTMENT MODE IN

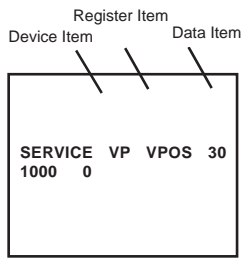

3. The CRT displays the item being adjusted.
4. Press **2** or **5** on the Remote Commander to select the device item.
5. Press **1** or **4** on the Remote Commander to select the item.
6. Press **3** or **6** on the Remote Commander to change the data.
7. To recover the latest values, press "0" then **ENTER**.
8. Press **MUTING** then **ENTER** to write into memory.

##### SERVICE ADJUSTMENT MODE MEMORY

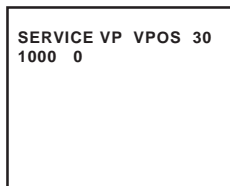

**MUTING** Green



**ENTER** Red

9. Press **8** then **ENTER** on the Remote Commander to reset.

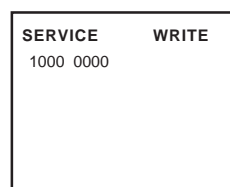

Carry out step 8 when adjusting IDs 0 to 4 and when replacing and adjusting IC102.

10. Turn set off and on to exit.

#### (2) Memory Write Confirmation Method

1. After adjustment, pull out the plug from the AC outlet, then replace the plug in the AC outlet again.
2. Turn the power switch ON and set to Service Mode.
3. Call the adjusted items again to confirm they were adjusted.

#### (3) Adjust Buttons and Indicator

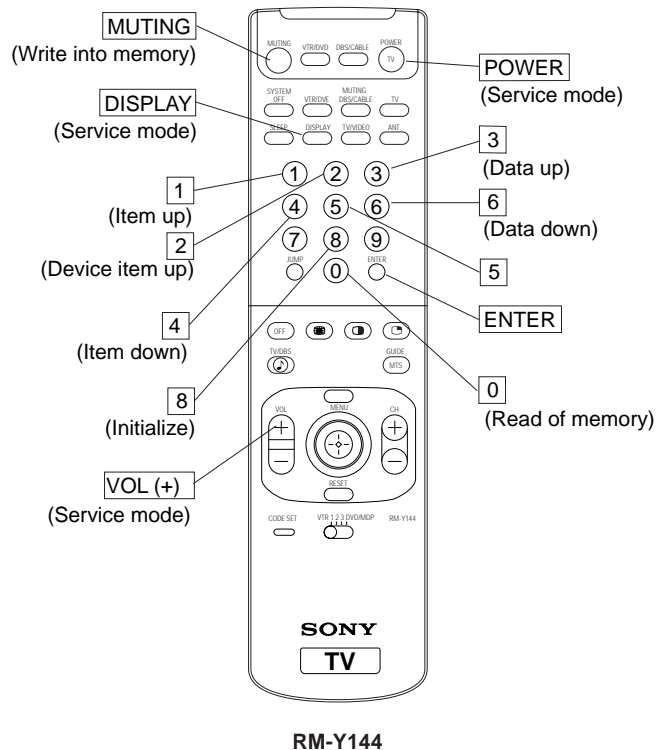

## (4) Service Data

No.	Register Name	Description	Data Range	Adj/Fix	Initial Data	Avg.
<b>VP CXA2095AS</b>						
1	VPOS	V-Position	0-63	Adjust	20	21
2	VSIZ	V-Size	0-63	Adjust	20	38
3	PVSZ	V-Size	0-63	Adjust	20	31
4	VCOM	V-Compensation	0-3	Fix	1	1
5	VLIN	V-Linearity	0-15	Adjust	7	12
6	VSCO	S-Correction	0-15	Adjust	7	8
7	HPOS	H-Position	0-15	Adjust	7	14
8	HSIZ	H-Size	0-63	Adjust	18	23
9	PHSZ	H-Size	0-63	Adjust	20	9
10	PAMP	PIN-Compensation	0-63	Adjust	31	19
11	UPIN	Upper-CornerPin	0-15	Adjust	7	6
12	LPIN	Lower-CornerPin	0-15	Adjust	7	8
13	PPHA	Pin-Phase	0-15	Adjust	7	3
14	AFC	AFC	0-3	Fix	2	2
15	VBOW	AFC-Bow	0-15	Adjust	7	8
16	VANG	AFC-Angle	0-15	Adjust	7	3
17	REF	Reference-Position	0-3	Fix	2	2
18	GDRV	Green-Drive	0-63	Adjust	31	31
19	BDRV	Blue-Drive	0-63	Adjust	31	25
20	GCUT	Green-Cutoff	0-15	Adjust	7	3
21	BCUT	Blue-Cutoff	0-15	Adjust	7	10
22	4GDR	Green-Drive	0-63	Adjust	31	29
23	4BDR	Blue-Drive	0-63	Adjust	31	24
24	4GCT	Green-Cutoff	0-15	Adjust	7	8
25	4BCT	Blue-Cutoff	0-15	Adjust	7	11
26	SCON	Sub-Contrast	0-15	Adjust	7	6
27	SHUE	Sub-Hue	0-15	Adjust	7	6
28	SCOL	Sub-Color	0-15	Adjust	7	7
29	SBRT	Sub-Brightness	0-63	Adjust	31	30
30	SSHP	Sub-Sharpness	0-15	Fix	7	7
31	CDM2	Count Down Mode2	"0, 1"	Fix	1	1
32	DPIX	Dynamic-Picture	"0, 1"	Fix	1	1
33	Y-DC	DC-Transmission	"0, 1"	Fix	1	1
34	ABLM	ABL	"0, 1"	Fix	1	1
35	NOTC	CromaTrap	"0, 1"	Fix	0	0
36	CROM	CromaTrap-Adjust	0-15	Fix	7	7
37	TOT	TOT-Filter	"0, 1"	Fix	1	1
38	PREL	Pre/Over-Shoot	0-3	Fix	0	0
39	SHPF	Sharpness-f0	0-3	Fix	2	2
40	RON	Red-Off	"0, 1"	Fix	1	1
41	GON	Green-Off	"0, 1"	Fix	1	1
42	BON	Blue-Off	"0, 1"	Fix	1	1
43	CDMD	V-Countdown	"0, 1"	Fix	0	0
44	HBSW	HBLKSW	"0, 1"	Fix	0	0
45	LBLK	Left Blanking	0-15	Fix	7	7
46	RBLK	Right Blanking	0-15	Fix	7	7
<b>AP BH3856</b>						
47	SVOL	Sub-Volume	0-15	Fix	0	0
48	SBAL	Sub-Balance	0-15	Fix	7	7
49	SBAS	Sub-Bass	0-15	(Fix by Model)	7	7
50	STRE	Sub-Treble	0-15	(Fix by Model)	7	7
<b>TS TC9447F</b>						
51	TB0U	B0h Upper 8bit	0-255	Fix	0	0
52	TB0L	B0h Lower 8bit	0-255	Fix	0	0
53	TB1U	B1h Upper 8bit	0-255	Fix	0	0
54	TB1L	B1h Lower 8bit	0-255	Fix	0	0
55	TB2U	B2h Upper 8bit	0-255	Fix	57	57
56	TB2L	B2h Lower 8bit	0-255	Fix	0	0

No.	Register Name	Description	Data Range	Adj/Fix	Initial Data	Avg.
57	TBFU	BFh Upper 8bit	0-255	Fix	166	166
58	TBFL	BFh Lower 8bit	0-255	Fix	0	0
59	TC0U	C0h Upper 8bit	0-255	Fix	90	90
60	TC0L	C0h Lower 8bit	0-255	Fix	0	0
61	TC1U	C1h/C7h Upper 8bit	0-255	Fix	79	49
62	TC1L	C1h/C7h Lower 8bit	0-255	Fix	0	0
63	MADU	ADh Upper 8bit	0-255	Fix	64	64
64	MADL	ADh Lower 8bit	0-255	Fix	0	0
65	MB0U	B0h Upper 8bit	0-255	Fix	92	92
66	MB0L	B0h Lower 8bit	0-255	Fix	0	0
<b>3D uPD6488</b>						
67	CGAN	CGAIN	"0, 1"	Fix	1	1
68	AVAP	AVAPON	"0, 1"	Fix	1	1
69	MS	MS0/MS1	0-2	Fix	0	0
70	YDLL	YDELAY-L	0-7	Fix	2	2
71	HRD8	HRD08	"0, 1"	Fix	0	0
72	HRD7	HRD00-07	0-255	Fix	12	12
73	DYCO	DYCOR	0-15	Fix	5	5
74	DYGA	DYGAIN	0-15	Fix	8	8
75	DCCO	DCCOR	0-15	Fix	3	3
76	DCCG	DCGAIN	0-15	Fix	7	7
77	VTR0	VTR0/VTR1	0-2	Fix	0	0
78	VTRH	VTRH	0-2	Fix	2	2
79	VTRR	VTRR	0-15	Fix	7	7
80	SELJ	SELJ	"0, 1"	Fix	1	1
81	HSDR	HSDR	0-15	Fix	7	7
82	WSCO	WSCOR	0-15	Fix	15	15
83	LDSR	LDSREF	0-15	Fix	7	7
84	WSD1	WSDR1	0-15	Fix	15	15
85	WSD2	WSDR2	0-15	Fix	15	15
86	VAPG	VAPGAIN	0-7	Fix	4	4
87	VAPI	VAPINV	0-31	Fix	15	15
88	MDTE	MDTES	"0, 1"	Fix	0	0
89	YTM8	YTM87	"0, 1"	Fix	0	0
90	DYTR	DYTRAP	"0, 1"	Fix	1	1
91	VHG	VHG	0-3	Fix	3	3
92	YH87	YH87	"0, 1"	Fix	0	0
93	YSG	YSG	"0, 1"	Fix	1	1
94	YTG	YTG	0-3	Fix	1	1
95	VTMR	YTMREF	0-15	Fix	12	12
96	VHRE	VHREF	0-15	Fix	11	11
97	YT1R	YT1REF	0-15	Fix	2	2
98	CT2Y	CT2YT	"0, 1"	Fix	0	0
99	CTG	CTG	0-3	Fix	1	1
100	CTMR	CTMREF	0-15	Fix	10	10
101	CT2R	CT2REF	0-15	Fix	10	10
102	CT1R	CT1REF	0-15	Fix	7	7
<b>PITA1226N</b>						
103	SHPR	Sharpness	0-127	Fix	59	59
104	SRTS	SRT Start Position	"0, 1"	Fix	3	3
105	GIRE	Gamma Start Point	0-3	Fix	3	3
106	GCUR	Gamma Curve	"0, 1"	Fix	0	0
107	RS	RS	0-7	Fix	0	0
108	RTC	RTC	0-7	Fix	4	4
<b>DC CXA2026AS</b>						
109	DCSF	DCSHIFT	0-63	Fix or Adjust	32	41
110	UYBW	UYBOW	0-63	Fix	31	31
111	LYBW	LYBOW	0-63	Fix	31	31
112	HAMP	HAMP	0-63	Fix or Adjust	23	9

No.	Register Name	Description	Data Range	Adj/Fix	Initial Data	Avg.
113	UCBW	UCBOW	0-63	Fix	14	14
114	LCBW	LCBOW	0-63	Fix	14	14
115	UMBH	UMBH	0-63	Fix	15	15
116	LMBH	LMBH	0-63	Fix	15	15
117	PWM	PWM	0-63	Fix	63	63
118	HTLT	HTILT	0-63	Fix	63	63
119	UTLT	UTILT	0-63	Fix	63	63
120	LTLT	LTILT	0-63	Fix	63	63
121	HDTY	HDUTY	0-4	Fix	3	3
122	TOFF	TILT OFF	"0, 1"	Fix	1	1
123	DAC0	DAC0	0-255	Fix	255	255
124	DAC1	DAC1	0-255	Fix	255	255
<b>PP SAB9076</b>						
125	SMT6	SMART6	"0, 1"	Fix	1	1
126	SKP6	SKIP6	"0, 1"	Fix	0	0
127	BGHP	BGhfp	0-15	Adjust	7	8
128	BGVP	BGVfp	0-15	Adjust	8	8
129	MAHP	MAhfp	0-15	Adjust	6	6
130	MAVP	MAvfp	0-255	Adjust	24	24
131	SAHP	SAhfp	0-15	Fix	3	3
132	SAVP	SAvfp	0-255	Fix	24	24
133	VPED	PedestV	0-15	Fix	14	0
134	UPED	PedestU	0-15	Fix	14	0
135	MDEC	"16h, bit 0-4"	0-32	Fix	18	18
136	SDEC	"15h, bit 0-4"	0-32	Fix	16	16
137	DISS	"17h, bit 0-7"	0-126	Fix	2	2
138	BSIZ	—	0-255	Fix	34	34
139	POFH	—	0-15	Fix	11	11
140	POFV	—	0-15	Fix	6	6
141	DHPS	Display H Position Start	0-15	Fix	4	5
142	P&PV	"SDhf , MDhfp under P&P"	0-255	Fix	62	62
143	BBR0	—	0-3	Fix	1	1
144	BCL0	—	0-7	Fix	7	7
145	BBR2	—	0-3	Fix	2	2
146	BCL2	—	0-7	Fix	6	6
147	BBR3	—	0-3	Fix	0	0
148	BCL3	—	0-7	Fix	7	7
<b>SP SDA9288</b>						
149	PYSD	Select Delay	0-15	Fix	3	3
150	PIPH	PIP H-Position	0-127	Fix	78	78
151	PIPV	PIP V-Position	0-63	Fix	18	18
152	PYDL	PIP Y-delay	0-7	Fix	0	0
153	PHDL	H-pulse delay	0-15	Fix	3	3
154	PMVD	Main V-pulse delay	0-31	Fix	16	16
155	PIVD	Inset V-pulse delay	0-31	Fix	22	22
156	PCON	Inset Contrast	0-15	Fix	7	7
157	FRMY	Frame Y	0-15	Fix	7	7
158	CHRI	Input Polarity	"0, 1"	Fix	1	1
159	CHRO	Output Polarity	"0, 1"	Fix	1	1
160	IPER	Inset Pedestal R-Y	0-15	Fix	0	0
161	IPEB	Inset Pedestal B-Y	0-15	Fix	0	0
162	PCPS	CLPS Blt Control	"0, 1"	Fix	0	0
163	PCPF	CLPFIX Blt Control	"0, 1"	Fix	0	0
164	PSEL	SELDOWN Bit Control	"0, 1"	Fix	1	1
165	PPLL	PLL Filter Bits	0-3	Fix	1	0
166	PVNR	PVNR bit	"0, 1"	Fix	0	1
<b>MC CXA2019</b>						
167	MHUE	HUE	0-63	Fix	26	26
168	MCOL	COLOR	0-63	Fix	35	35

No.	Register Name	Description	Data Range	Adj/Fix	Initial Data	Avg.
169	MSCO	SUB CONT	0-15	Adjust	7	7
170	MSCL	SUB COLOR	0-15	Adjust	7	7
171	MSHU	SUB HUE	0-15	Adjust	7	7
172	MTOT	TOT ON	"0, 1"	Fix	1	1
173	MTRP	TRAP ON	"0, 1"	Fix	0	0
174	MTRA	CTRAPADJ	0-15	Fix	7	7
175	MCD2	CD MODE2	"0, 1"	Fix	1	1
176	MFSC	FSC OUT	"0, 1"	Fix	1	1
177	MYDR	Y DRIVE	0-31	Fix	22	22
178	MVPE	V PED	0-15	Adjust	7	7
179	MUPE	U PED	0-15	Adjust	7	7
180	MRVP	RV PED	0-15	Fix	0	0
181	MRUP	RU PED	0-15	Fix	0	0
182	MDCT	DC TRAN	0-7	Fix	0	0
183	MRYD	RY DRIVE	0-31	Fix	31	31
184	MPRE	PRE OVER	0-3	Fix	0	0
185	MRUD	RU DRIVE	0-31	Fix	15	15
186	MRVD	RV DRIVE	0-31	Fix	15	15
187	MDLY	DELAY	0-3	Fix	0	0
188	MSCR	SCP BGR	0-3	Fix	1	1
189	MSCF	SCP BGF	0-3	Fix	1	1
<b>IC CXA2019</b>						
190	ICYC	CV/YC	"0, 1"	(Fix by Model)	1	1
191	IHUE	HUE	0-63	Fix	24	24
192	ICOL	COLOR	0-63	Fix	37	37
193	ISCO	SUB CONT	0-15	Adjust (FD7)	6	7
194	ISCL	SUB COLOR	0-15	Adjust (FD7)	7	7
195	ISHU	SUB HUE	0-15	Adjust (FD7)	7	7
196	ITOT	TOT ON	"0, 1"	Fix	1	1
197	ITRP	TRAP ON	"0, 1"	Fix	0	0
198	ITRA	CTRAPADJ	0-15	Fix	7	7
199	ICD2	CD MODE2	"0, 1"	Fix	1	1
200	IYDR	Y DRIVE	0-31	Fix	24	24
201	IVPE	V PED	0-15	Adjust (FD7)	7	7
202	IUPE	U PED	0-15	Adjust (FD7)	7	7
203	IRVP	RV PED	0-15	Fix	0	0
204	IRUP	RU PED	0-15	Fix	2	2
205	IDCT	DC TRAN	0-7	Fix	0	0
206	IRYD	RY DRIVE	0-31	Fix	31	31
207	IPRE	PRE OVER	0-3	Fix	0	0
208	IRUD	RU DRIVE	0-31	Fix	15	15
209	IRVD	RV DRIVE	0-31	Fix	15	15
210	IDLY	DELAY	0-3	Fix	0	0
211	ISCR	SCP BGR	0-3	Fix	1	1
212	ISCF	SCP BGF	0-3	Fix	1	1
<b>DA CXA1315</b>						
213	RTCO	DAC0 (Rotation Coil)	0-63	Fix	32	32
214	2HUE	DAC1 (CXA2039 Hue)	0-63	Adjust	28	28
215	2COL	DAC2 (CXA2039 COL)	0-63	Adjust	31	42
<b>CC CXP858</b>						
216	CRIL	CRI Count Low	0-15	Fix	2	2
217	CFLD	"Feild Count for VCR FF,REV"	0-15	Fix	5	5
218	CCDI	CCD INT	0-7	Fix	3	3
219	CRIP	CRI & Parity	0-7	Fix	4	4
220	CRIT	CRI Time Constant	0-3	Fix	-	1
221	CSB1	Sync Slice Bias 1	0-3	Fix	3	3
222	CSB2	Sync Slice Bias 2	0-7	Fix	4	4
223	CREP	CRI Signal End Position	0-256	Fix	142	142
224	CSDS	Data Start Delay	0-31	Fix	8	8



No.	Register Name	Description	Data Range	Adj/Fix	Initial Data	Avg.
225	CCDS	Caption Data Threshold	0-31	Fix	9	9
226	CHMK	p8_hmask	0-63	Fix	42	42
227	CHSY	p8_hsync	0-255	Fix	136	136
<b>OP CXP858/CXA2025 Color</b>						
228	DISP	OSD Position	0-63	(Touch Up)	1	13
229	PDPS	PIP Display Position Start	0-63	(Touch Up)	1	35
230	PDP0	PIP Display Position 0	0-3	(Touch Up)	1	1
231	PDP1	PIP Display Position 1	0-7	(Touch Up)	4	4
232	PDP2	PIP Display Position 2	0-7	(Touch Up)	4	3
233	KILS	Color Killer SW	"0, 1"	-	1	1
<b>ID 0-5</b>						
234	ID-0	ID-0 (Language: 89/25/9)	0-255	Fix by Model	89	89
235	ID-1	ID-1	0-255	Fix	63	63
236	ID-2	D-2 (Audio Effect)	0-255	Fix by Model	63	63
237	ID-3	ID-3 (Front Control: 0/64)	0-255	Fix by Model	0	0
238	ID-4	ID-4 (Auto Shut Off: 139/171)	0-255	Fix by Model	139	139
239	ID-5	ID-5	0-255	-	137	137
<b>ID 6-7</b>						
240	ID-6	ID-6 (PinP/P&P)	0-255	Fix by Model	38	38
241	ID-7	ID-7	0-255	Fix	0	0

SERVICE IDO 25
----------------

Note: Items 1-241 show adjustment order.

**(5) Feature ID Map**

KV-NO	Dest	ID 0	ID 1	ID 2	ID 3	ID 4	ID 5	ID 6	ID 7
KV-32XBR200	US	89	63	63	0	139	173	38	0
KV-32XBR200	CND	89	63	63	0	139	173	38	0
KV-36XBR200	US	89	63	63	0	139	173	38	0
KV-36XBR200	CND	89	63	63	0	139	173	38	0

**SUB BRIGHT ADJUSTMENT (SBRT)**

1. Set to Service adjustment Mode.
2. Input a gray scale pattern signal.
3. Set the PICTURE to minimum, and BRIGHT to normal.
4. Select SBRT with **[1]** and **[4]**.
5. Adjust SUB BRIGHT level with **[3]** and **[6]** so that the stripe second from the right is faintly visible.
6. Write into the memory by pressing **[MUTING]** then **[ENTER]**.

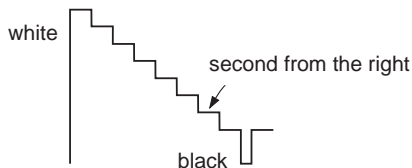
**SUB CONTRAST ADJUSTMENT (SCON)**

1. Input a 75% color-bar signal.
2. Set to VIDEO mode = STANDARD, COLOR = minimum, PICTURE = 100%.  
GON = 0 (OFF), BON = 0 (OFF).
3. Set to Service adjustment Mode and Connect an oscilloscope pin ① of CN351 on A Board.
4. Select SCON with **[1]** and **[4]**.
5. Adjust with **[3]** and **[6]** for the  $1.90 \pm 0.05V_{p-p}$  of level.
6. Write into the memory by **[MUTING]** then **[ENTER]**.

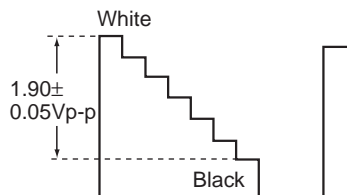
**SUB HUE, SUB COLOR ADJUSTMENT (SHUE, SCOL)**

1. Input a color bar signal.
2. Set to Service adjustment Mode and set to VIDEO mode = STANDARD  
PICTURE = 100%  
COLOR = 50%  
HUE = 50%.
3. Connect an oscilloscope to CN351 Pin ③ of A Board.
4. Select SHUE and SCOL with **[1]** and **[4]**.
5. Adjust with **[3]** and **[6]** for the  $V1 = V4$  (SCOL) and  $V2 = V3$  (SHUE).
6. After adjustment write SHUE data 1 step down and SCOL data 2 steps up.
7. Write into the memory by pressing **[MUTING]** then **[ENTER]**.

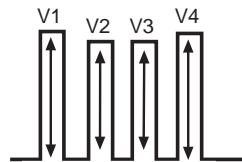
**H. SIZE ADJUSTMENT (HSIZ)**

1. Input a monoscope signal.
2. Set to Service adjustment Mode.
3. Select HSIZ with **[1]** and **[4]**.
4. Adjust with **[3]** and **[6]** for the best Horizontal size.
5. Write into the memory by pressing **[MUTING]** then **[ENTER]**.

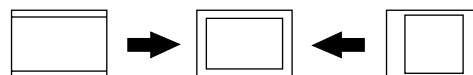
**H. SIZE**

**V. SIZE ADJUSTMENT (VSIZ)**

1. Input a monoscope signal.
2. Set to Service adjustment mode.
3. Select VSIZ with **[1]** and **[4]**.
4. Adjust with **[3]** and **[6]** for the best vertical size.
5. Write into the memory by pressing **[MUTING]** then **[ENTER]**.

V. SIZE

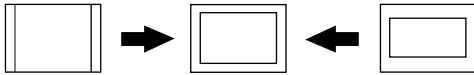
**V. POSITION ADJUSTMENT (VPOS)**

1. Input a monoscope signal.
2. Set to Service adjustment Mode.
3. Select VPOS with **[1]** and **[4]**.
4. Adjust with **[3]** and **[6]** for the best vertical center.
5. Write into the memory by pressing **[MUTING]** then **[ENTER]**.

V. POSITION

**H. POSITION ADJUSTMENT (HPOS)**

Perform this adjustment after H. FREQUENCY ADJ. (HFRE).

1. Input a monoscope signal.
2. Set the Service adjustment Mode.
3. Select HPOS with **[1]** and **[4]**.
4. Adjust with **[3]** and **[6]** for the best horizontal center.
5. Write into the memory by pressing **[MUTING]** then **[ENTER]**.

H. POSITION

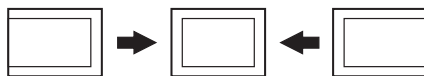
**V LINEARITY (VLIN), V CORRECTION (VSCO), PIN AMP (PAMP) AND PIN PHASE (PPHA) ADJUSTMENTS**

1. Input a cross-hatch signal.
2. Set to Service adjustment Mode.
3. Select VLIN, VSCO, PAMP, and PPHA with **[1]** and **[4]**.
4. Adjust with **[3]** and **[6]** for the best picture.
5. Write the memory by Pressing **[MUTING]** then **[ENTER]**.

V LINEARITY(VLIN)

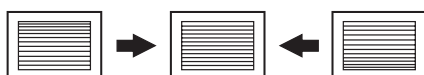

VS CORRECTION (VSCO)

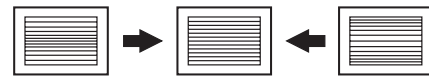

PIN AMP (PAMP)

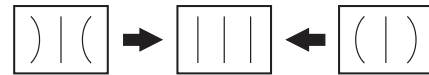

PIN PHASE (PPHA)

**V ANGLE (VANG), V BOW (VBOW), UPPER PIN (UPIN) AND LOW PIN (LPIN) ADJUSTMENTS**

1. Input a cross hatch signal.
2. Set to Service adjustment Mode.
3. Select VVANG, VBOW, UPIN, and LPIN with **[1]** and **[4]**.
4. Adjust with **[3]** and **[6]** for the best picture.
5. Write the memory by Pressing **[MUTING]** then **[ENTER]**.

V ANGLE (VANG)

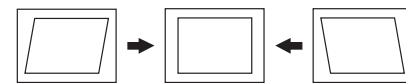

V BOW (VBOW)

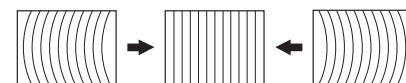

UPPER PIN (UPIN)

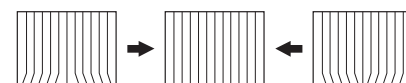

LOW PIN (LPIN)

**A BOARD****Y/B-Y/R-Y LEVEL ADJUSTMENT**

1. Set: VIDEO mode = STANDARD  
PICTURE = 100%  
COLOR = 50%  
HUE = 50%
2. Set a select Video 4 (DVD) Mode.
3. Input a 75% color bar signal.

4. Connect an oscilloscope to CN351 pin ③ on A board.
5. Set to Service Mode and select 2COL and 2HUE with [1] and [4].
6. Adjust with [3] and [6] for 2COL and 2HUE so that even flat signal.
7. After adjust write 2HUE data 4 steps down.
8. Write into the memory by pressing [MUTING] then [ENTER] .

(75 ohms open level)  
Y LEVEL (INPUT)

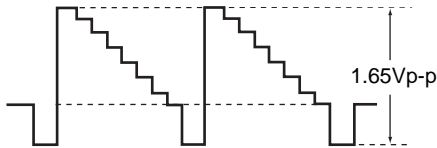

B-Y LEVEL (INPUT)

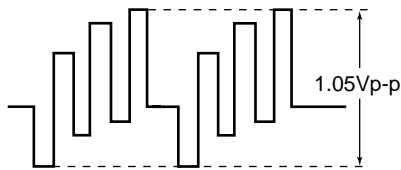

R-Y LEVEL (INPUT)

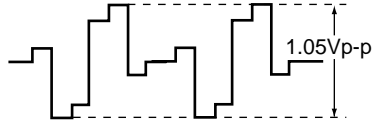

### P&P SUB CONTRAST ADJUSTMENT (MSCO, ISCO)

1. Input a 75% color-bar signal.
2. Set: VIDEO mode = STANDARD  
PICTURE = 100%  
COLOR = minimum  
GON = 0 (OFF), BON = 0(OFF),  
TRINITONE = medium.
3. Set P&P mode.
4. Connect an oscilloscope to CN1103 pin ④ of A board and GND.
5. Set to Service Mode and select MSCO (main window) and ISCO (sub window) with [1] and [4].
6. Adjust with [3] and [6] for the  $1.75 \pm 0.05V_{p-p}$  of level.
7. Write into the memory by pressing [MUTING] then [ENTER].

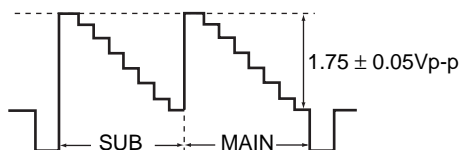

### P&P SUB COLOR, SUB HUE ADJUSTMENT (MCO, MSHU, ICOL, ISHU)

1. Input a 75% Color-bar signal.
2. Set: VIDEO mode = STANDARD  
PICTURE = 100%  
COLOR = 50%  
HUE = 50%,  
TRITONE = medium.
3. Set P&P mode.
4. Connect an oscilloscope to CN1103 pin ⑤ of A board and GND.
5. Set to Service Mode and select MCOL , MSHU (main window) and ICOL, ISHU (sub window) with [1] and [4].
6. Adjust with [3] and [6].
7. After adjust write MSHU and ISHU data 1 step down.
8. Write into the memory by pressing [MUTING] then [ENTER] .

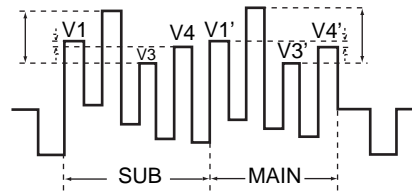

#### *SUB COLOR*

$V1-V4 = \pm 0.1V$   
 $V1'-V4' = \pm 0.1V$

#### *SUB HUE*

$V3-V2 = \pm 0.1V \rightarrow 1 \text{ STEP DOWN}$   
 $V3'-V2' = \pm 0.1V \rightarrow 1 \text{ STEP DOWN}$

### P&P ACQUISITION ADJUSTMENT (MAHP, MAVP)

1. Input a Monoscope signal.
2. Set PICTURE = 100%.
3. Set P&P mode and set CHANNEL INDEX mode.
4. Set to Service Mode and select MAHP and MAVP with [1] and [4].
5. Adjust with [3] and [6] for the best center (main window).
6. Write the memory by pressing [MUTING] then [ENTER] .

#### NEED TO ADJUST AFTER GEOMETRIC ADJUST

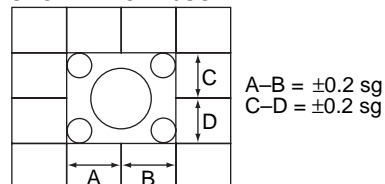

**BACKGROUND POSITION ADJUSTMENT (BGHP, BGVP)**

NOTE: Prior to this adjustment, the P&P ACQUISITION ADJUSTMENT must be performed (see previous page).

1. Input a monoscope signal.
2. Set VIDEO mode = STANDARD.
3. Freeze a main picture.
4. Set to Service Mode and select BGHP (pp), BGVP (pp) with **[1]** and **[4]**.
5. Adjust with **[3]** and **[6]** for the best center.
6. Write into the memory by pressing **[MUTING]** then **[ENTER]**.

**FREEZED**  
 •NEED TO ADJUST AFTER P&P (MAIN) ACQUISITION ADJUST

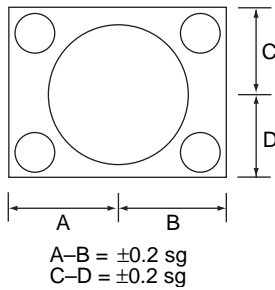

**P&P WHITE BALANCE ADJUSTMENT (MUPE, MVPE, IUPE, IVPE)**

1. Input a 40 IRE white signal.
2. Set to VIDEO mode = STANDARD.
3. Set to P&P mode.
4. Set to Service Mode and select MUPE MVPE (main window), IUPE IVPE (sub window) with **[1]** and **[4]** .
5. Adjust with **[3]** and **[6]** for white balance.
6. Write into the memory by pressing **[MUTING]** then **[ENTER]** .

NEED TO ADJUST AFTER MAIN PICTURE (NOT P&P) W/B ADJUST

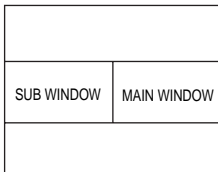

\*9300 degrees K +8 MPCD

**P&P OSD ADJUSTMENT (PDPS)**

1. Input a monoscope signal.
2. Set to channel INDEX mode.
3. Adjust so right side edge of P&P OSD is 1 ~ 2 characters from border.  
 ADJUST.....PDPS (OP)  
 If necessary, adjust PDP 0  
 PDP 1  
 PDP 2
4. Push the P&P off.
5. Push the return key for favorite channel.
6. Confirm 1 ~ 2 characters distance.
7. Write the memory by pressing **[MUTING]** then **[ENTER]** .

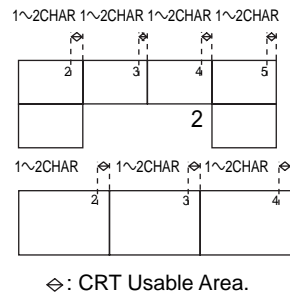

**OSD POSITION ADJUSTMENT (DISP)**

1. Input a color bar signal.
2. Set to Service adjustment Mode.
3. Select DISP with **[1]** and **[4]**.
4. Adjust with **[3]** and **[6]** for the bar center.
5. Write into the memory by pressing **[MUTING]** then **[ENTER]** .

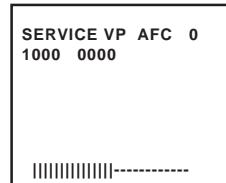

## H-CENTERING ADJUSTMENT

1. Input a monoscope signal.
2. Set to Standard Mode.
3. Push the "TEST + JUMP".
4. Set adjust the G2 VR that the raster appear.
5. Set H-SIZE minimum.
6. Adjust H-Center SW (S501) so that the margin width (no raster) of left side and right side no raster area's width is almost the same.

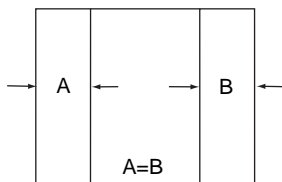

## P&P SCON ADJUSTMENT

1. Input a color-bar signal signal.
2. Set to service adjustment mode and set to GON and BON to "0".
3. Set P&P mode.
4. Connect an pscilloscope CN 1103 (6 pin) of A board.
5. Select MSCO (main) ISCO (sub) with **1** and **4**.
6. Adjust with **3** and **6** as below.

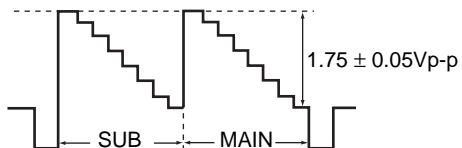

### 6-3. CIRCUIT BOARDS LOCATION

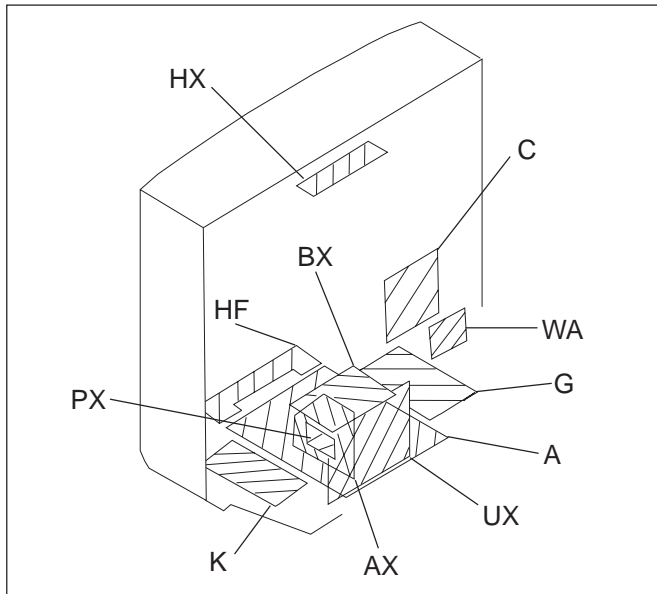

### 6-4. PRINTED WIRING BOARDS AND SCHEMATIC DIAGRAMS

- All capacitors are in  $\mu\text{F}$  unless otherwise noted.  $\text{pF}$  :  $\mu\text{F}$  50VV or less are not indicated except for electrolytics and tantalums.
- All electrolytics are in 50V unless otherwise specified.
- All resistors are in ohms.  
K =1000 , M =1000k
- Indication of resistance, which does not have one for rating electrical power, is as follows.

Pitch : 5mm  
Rating electrical power :  $\frac{1}{4}\text{W}$

- $\frac{1}{4}\text{W}$  in resistance,  $\frac{1}{10}\text{W}$  and  $\frac{1}{8}\text{W}$  in chip resistance.
- : nonflammable resistor.
- : fusible resistor.
- $\Delta$  : internal component.
- : panel designation and adjustment for repair.
- All variable and adjustable resistors have characteristic curve B, unless otherwise noted.
- The components identified by in this basic schematic diagram have been carefully factory-selected for each set in order to satisfy regulations regarding X-ray radiation.  
Should replacement be required, replace only with the value originally used.
- When replacing components identified by , make the necessary adjustments indicated. If results do not meet the specified value, change the component identified by and repeat the adjustment until the specified value is achieved. (Refer to R530 and R531 adjustment on Page 19.)
- When replacing the part in below table, be sure to perform the related adjustment.
- Readings are taken with a color-bar signal input.
- Readings are taken with a 10M digital multimeter .
- Voltages are DC with respect to ground unless otherwise noted.
- Voltage variations may be noted due to normal production tolerances.
- All voltages are in V.

Part replaced()	Adjustment()
IC351,IC501,D519,D520,D521 C531,C532,R387,R529,R530,R531, R532,R533,R550,T503.....A BOARD IC643,R661.....G BOARD	R530,R531

S : Measurement impossibility.

- : B+line.
- : B-line.  
(Actual measured value may be different).
- : signal path. (RF)
- Circled numbers are waveform references.

Reference information

RESISTOR	: RN	METAL FILM
	: RC	SOLID
	: FPRD	NONFLAMMABLE CARBON
	: FUSE	NONFLAMMABLE FUSIBLE
	: RW	NONFLAMMABLE WIREWOUND
	: RS	NONFLAMMABLE METAL OXIDE
	: RB	NONFLAMMABLE CEMENT
	:	ADJUSTMENT RESISTOR
COIL	: LF-8L	MICRO INDUCTOR
CAPACITOR	: TA	TANTALUM
	: PS	STYROL
	: PP	POLYPROPYLENE
	: PT	MYLAR
	: MPS	METALIZED POLYESTER
	: MPP	METALIZED POLYPROPYLENE
	: ALB	BIPOLAR
	: ALT	HIGH TEMPERATURE
	: ALR	HIGH RIPPLE

The symbol display is on the component side.  
The components identified by shading and mark  $\Delta$  are critical for safety. Replace only with part number specified.  
The symbol indicate fast operating fuse.  
Replace only with fuse of same rating as marked.

Les composants identifiés par un tramé et une marque  $\Delta$  sont critiques pour la sécurité. Ne les remplacer que par une pièce portant le numéro spécifié.  
Le symbole indique une fusible a action rapide. Doit etre remplacee par une fusible de meme yaleur, comme maque.





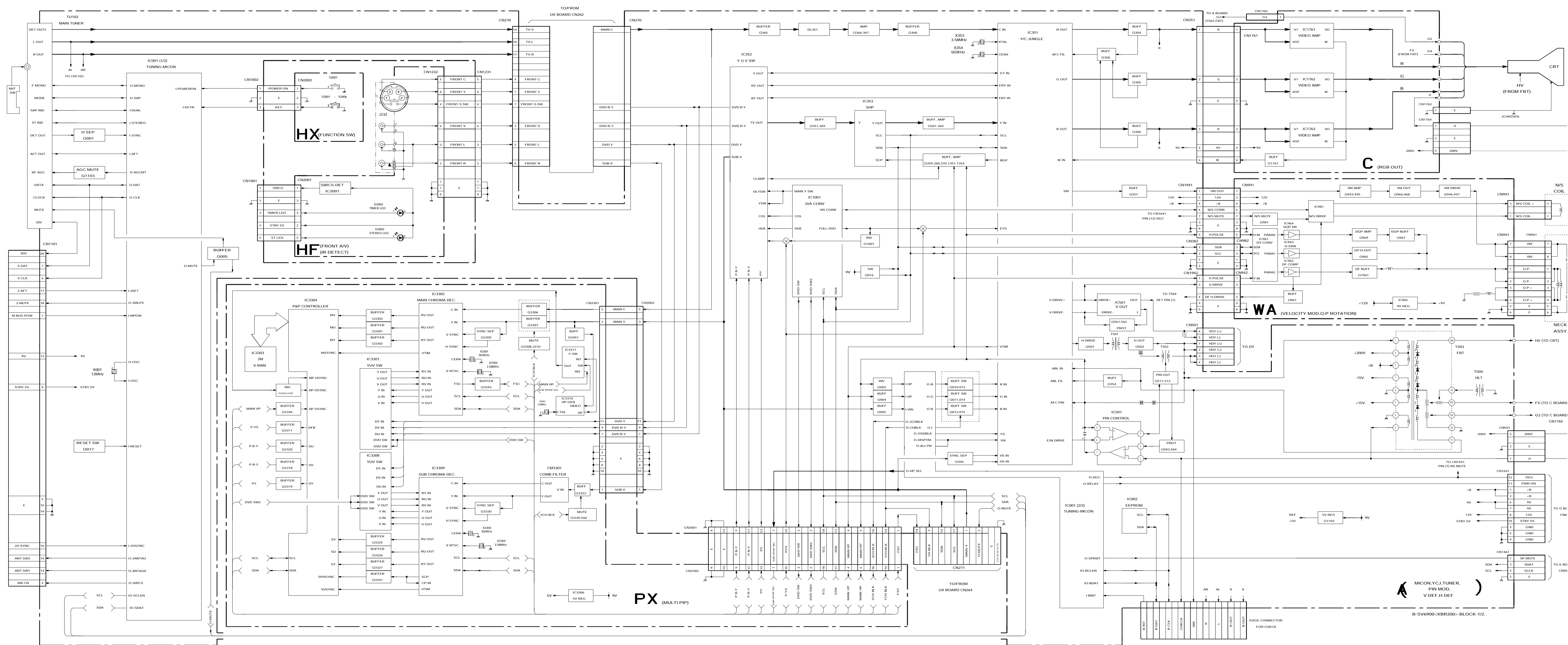

B-SV6900-XBR200-BLOCK-12.

### A BOARD TRANSISTOR VOLTAGE LIST

	B	C	E
Q001	4.9	0.7	4.8
Q002	4.9	9.5	4.2
Q003	0	3.9	GND
Q004	0.7	GND	1.2
Q005	0	4.8	0
Q010	0	9.5	0
Q011	0	9.5	0
Q012	0	9.5	0
Q013	0	0	GND
Q014	0	0	GND
Q015	0	0	GND
Q016	5.8	9.5	5.2
Q017	4.2	4.8	4.8
Q304	1.7	GND	2.4
Q305	1.7	GND	2.3
Q306	1.7	GND	2.3
Q351	6.7	9.2	6
Q354	0.2	GND	-0.3
Q356	5.1	GND	5.7
Q357	3.7	9.5	3.1
Q358	2.2	9.1	2.3
Q359	1.1	GND	1.9
Q360	0.2	11.6	0.7
Q361	7.6	11.6	6.9
Q362	3.2	10.8	2.6
Q363	10.8	5	11.4
Q364	5	GND	5.6
Q365	5	9.2	4.4
Q366	2.5	8.5	1.9
Q367	8.5	3.4	9.1
Q368	3.4	GND	4
Q369	3.6	9.2	2.9
Q370	1.9	11.6	1.4
Q501	-0.9	97	GND
Q502	0	134	GND
Q503	0	8.3	GND
Q504	-0.9	0	GND
Q507	0.7	0	GND
Q511	-14	-11	-14.2
Q512	-14.4	19.8	-14.2
Q561	0	3	GND
Q562	-0.2	0	GND
Q1001	0.2	2.2	GND
Q1102	5.7	8.9	5.1
Q1103	0	7.1	GND
Q1351	0.6	9.2	0.4
Q1352	-1.1	10.4	GND
Q1353	11.6	0.6	11.6
Q1354	-0.2	0	GND

All voltages are in V.

### K BOARD TRANSISTOR VOLTAGE LIST

	B	C	E
Q1461	0.7	0	GND
Q1462	0	11.5	GND
Q1463	0	0	GND
Q1464	0	0	GND

All voltages are in V.

### C BOARD TRANSISTOR VOLTAGE LIST

	B	C	E
Q1761	4.1	0.1	3.5

All voltages are in V.

### PX BOARD TRANSISTOR VOLTAGE LIST

	B	C	E
Q3301	2.9	GND	3.6
Q3302	3.3	GND	3.9
Q3303	2.9	GND	3.6
Q3305	5.8	GND	6.4
Q3306	5	GND	5.7
Q3307	5	GND	5.7
Q3308	0	5.8	GND
Q3309	0	5.8	GND
Q3310	0	9	0
Q3311	0	9	0
Q3318	1.3	GND	2
Q3319	0.5	GND	1.2
Q3320	1.3	GND	2
Q3325	3	GND	3.7
Q3326	2.9	GND	3.6
Q3327	2.9	GND	3.6
Q3330	4.9	GND	5.4
Q3333	5	GND	5.6
Q3339	0	5.7	GND
Q3342	0	9	0
Q3343	1.6	GND	2.3
Q3344	0.8	1	GND
Q3345	-0.5	1.4	GND
Q3346	0.8	9	0.6
Q3347	0.8	9	0.6
Q3451	5.1	8.2	6.6

All voltages are in V.

### UX BOARD TRANSISTOR VOLTAGE LIST

	B	C	E
Q202	2.8	7.8	2.2
Q203	2.6	7.8	2.2
Q205	7.8	4	8.3
Q206	7.8	4	8.3
Q208	4.4	8.8	3.5
Q209	4	8.8	3.5
Q210	2.8	7.8	2.2
Q211	7.8	4.1	8.4
Q212	4.1	8.8	3.4
Q231	-0.7	5	GND
Q233	-1.1	0	GND
Q234	-1.1	0	GND
Q235	0	0	GND
Q236	0	0	GND
Q237	4.3	GND	5.1
Q238	4.5	GND	5.1
Q239	4.5	GND	5.1
Q240	-0.2	5.1	GND
Q241	-0.3	5.1	GND
Q242	-0.3	5.1	GND
Q243	4.4	GND	5.1
Q244	4.4	GND	5.1
Q245	4.4	GND	5.1
Q246	0	5.1	GND
Q262	4.4	GND	5
Q263	4.3	GND	5
Q264	4.4	GND	5
Q265	4.7	8.8	4.1
Q266	4.4	GND	5
Q267	0.2	GND	0.9
Q268	8.1	GND	8.8
Q1051	8.8	-1.1	8.7

All voltages are in V.

### BX BOARD TRANSISTOR VOLTAGE LIST

	B	C	E
Q3701	1.5	GND	2.2
Q3702	0.1	GND	8.8
Q3703	2.3	8.6	1.7
Q3707	4.2	8.6	3.6
Q3708	0.5	GND	1.2
Q3709	1	GND	1.7
Q3719	3	5	2.3
Q3724	2.4	7.7	1.8
Q3725	7.7	4.5	8.4
Q3728	5.1	GND	5.8
Q3729	4.5	GND	5.2
Q3731	2.4	7.7	1.7
Q3732	7.7	5.1	8.4
Q3733	0	0.1	GND
Q3734	0.1	0	GND

All voltages are in V.

### AX BOARD TRANSISTOR VOLTAGE LIST

	B	C	E
Q101	5.8	8.7	5.1
Q103	4.1	4.7	4.8
Q104	4.8	0	4.8
Q105	4.8	1	4.8
Q106	4.7	8.7	4
Q1902	4.8	0	0
Q1903	4.8	0	0
Q1918	4.8	0	0

All voltages are in V.

### WA BOARD TRANSISTOR VOLTAGE LIST

	B	C	E
Q943	3.1	11.6	2.4
Q944	2.5	11.6	1.9
Q945	2.5	8.1	1.9
Q946	134.3	67.2	134.9
Q947	0.9	67.2	0.4
Q961	0.4	0.7	GND
Q962	0.5	GND	1.1
Q963	6.1	GND	6.2
Q966	8.1	GND	8.4
Q967	6.1	6	6.8
Q968	8.7	11.6	8.3
Q969	5.5	11.3	6
Q981	0	4.7	GND
Q1961	0	0	11.6
	D	G	S
Q965	0.7	6.2	GND

All voltages are in V.

### G BOARD TRANSISTOR VOLTAGE LIST

	B	C	E
Q622	0.3	1.4	GND
Q623	0.7	0	GND
Q624	12.7	0	12.4
Q644	0	11.9	GND
Q645	12.3	GND	9.2
Q646	5.7	6.3	6.3
Q647	0	12.4	GND
Q648	0.6	0.1	GND
Q649	12	0	12
Q650	0	2.4	0
Q651	135	0	135
Q652	3.6	0	3.6
Q653	0	3.6	GND
	D	G	S
Q621	151	1.4	0

All voltages are in V.

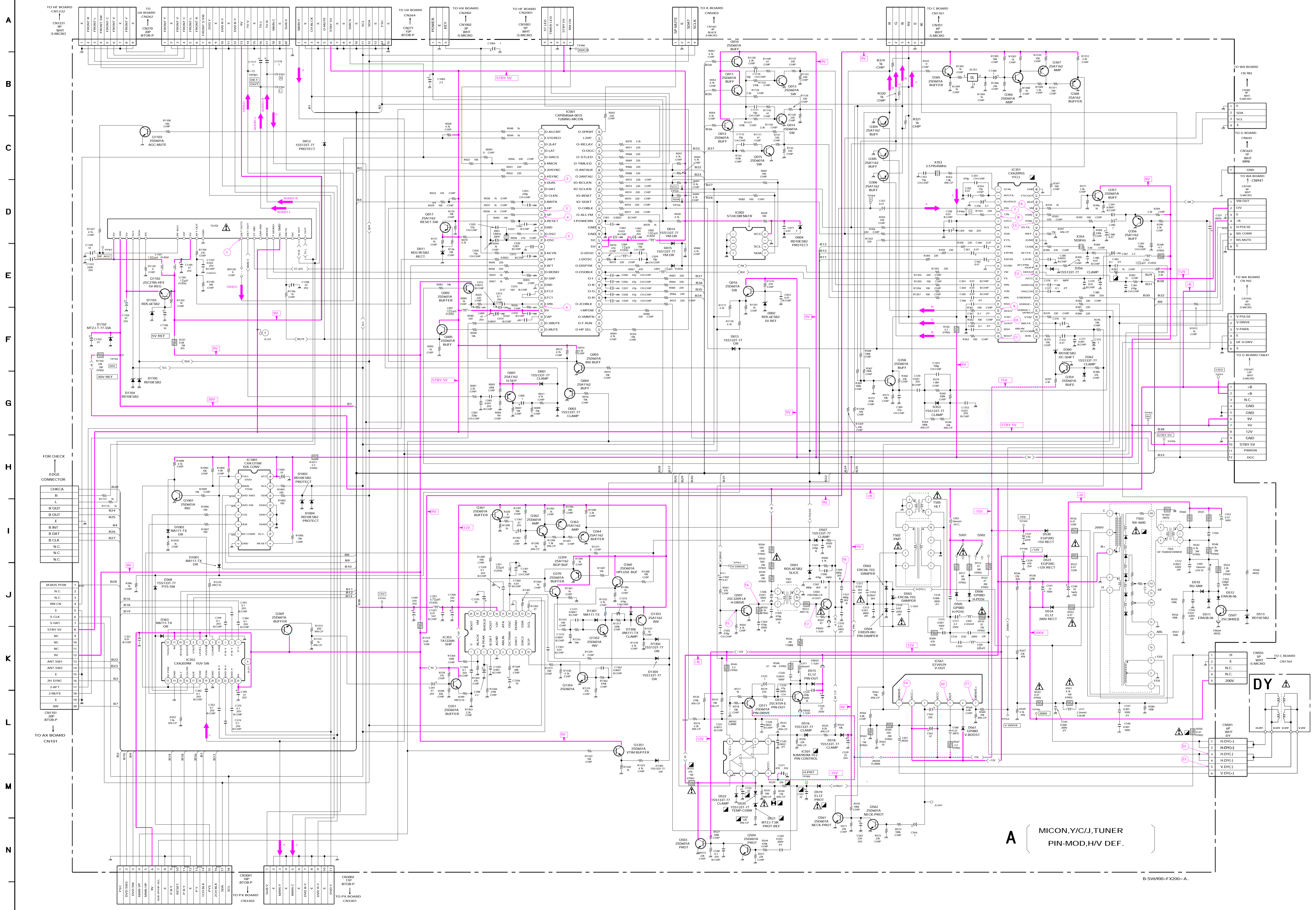

**A** MICON, Y/C/J, TUNER  
PIN-MOD, HV DEF.

### A BOARD TRANSISTOR VOLTAGE LIST

	B	C	E
Q001	4.9	0.7	4.8
Q002	4.9	9.5	4.2
Q003	0	3.9	GND
Q004	0.7	GND	1.2
Q005	0	4.8	0
Q010	0	9.5	0
Q011	0	9.5	0
Q012	0	9.5	0
Q013	0	0	GND
Q014	0	0	GND
Q015	0	0	GND
Q016	5.8	9.5	5.2
Q017	4.2	4.8	4.8
Q304	1.7	GND	2.4
Q305	1.7	GND	2.3
Q306	1.7	GND	2.3
Q351	6.7	9.2	6
Q354	0.2	GND	-0.3
Q356	5.1	GND	5.7
Q357	3.7	9.5	3.1
Q358	2.2	9.1	2.3
Q359	1.1	GND	1.9
Q360	0.2	11.6	0.7
Q361	7.6	11.6	6.9
Q362	3.2	10.8	2.6
Q363	10.8	5	11.4
Q364	5	GND	5.6
Q365	5	9.2	4.4
Q366	2.5	8.5	1.9
Q367	8.5	3.4	9.1
Q368	3.4	GND	4
Q369	3.6	9.2	2.9
Q370	1.9	11.6	1.4
Q501	-0.9	97	GND
Q502	0	134	GND
Q503	0	8.3	GND
Q504	-0.9	0	GND
Q507	0.7	0	GND
Q511	-14	-11	-14.2
Q512	-14.4	19.8	-14.2
Q561	0	3	GND
Q562	-0.2	0	GND
Q1001	0.2	2.2	GND
Q1102	5.7	8.9	5.1
Q1103	0	7.1	GND
Q1351	0.6	9.2	0.4
Q1352	-1.1	10.4	GND
Q1353	11.6	0.6	11.6
Q1354	-0.2	0	GND

All voltages are in V.

### K BOARD TRANSISTOR VOLTAGE LIST

	B	C	E
Q1461	0.7	0	GND
Q1462	0	11.5	GND
Q1463	0	0	GND
Q1464	0	0	GND

All voltages are in V.

### C BOARD TRANSISTOR VOLTAGE LIST

	B	C	E
Q1761	4.1	0.1	3.5

All voltages are in V.

### PX BOARD TRANSISTOR VOLTAGE LIST

	B	C	E
Q3301	2.9	GND	3.6
Q3302	3.3	GND	3.9
Q3303	2.9	GND	3.6
Q3305	5.8	GND	6.4
Q3306	5	GND	5.7
Q3307	5	GND	5.7
Q3308	0	5.8	GND
Q3309	0	5.8	GND
Q3310	0	9	0
Q3311	0	9	0
Q3318	1.3	GND	2
Q3319	0.5	GND	1.2
Q3320	1.3	GND	2
Q3325	3	GND	3.7
Q3326	2.9	GND	3.6
Q3327	2.9	GND	3.6
Q3330	4.9	GND	5.4
Q3333	5	GND	5.6
Q3339	0	5.7	GND
Q3342	0	9	0
Q3343	1.6	GND	2.3
Q3344	0.8	1	GND
Q3345	-0.5	1.4	GND
Q3346	0.8	9	0.6
Q3347	0.8	9	0.6
Q3451	5.1	8.2	6.6

All voltages are in V.

### UX BOARD TRANSISTOR VOLTAGE LIST

	B	C	E
Q202	2.8	7.8	2.2
Q203	2.6	7.8	2.2
Q205	7.8	4	8.3
Q206	7.8	4	8.3
Q208	4.4	8.8	3.5
Q209	4	8.8	3.5
Q210	2.8	7.8	2.2
Q211	7.8	4.1	8.4
Q212	4.1	8.8	3.4
Q231	-0.7	5	GND
Q233	-1.1	0	GND
Q234	-1.1	0	GND
Q235	0	0	GND
Q236	0	0	GND
Q237	4.3	GND	5.1
Q238	4.5	GND	5.1
Q239	4.5	GND	5.1
Q240	-0.2	5.1	GND
Q241	-0.3	5.1	GND
Q242	-0.3	5.1	GND
Q243	4.4	GND	5.1
Q244	4.4	GND	5.1
Q245	4.4	GND	5.1
Q246	0	5.1	GND
Q262	4.4	GND	5
Q263	4.3	GND	5
Q264	4.4	GND	5
Q265	4.7	8.8	4.1
Q266	4.4	GND	5
Q267	0.2	GND	0.9
Q268	8.1	GND	8.8
Q1051	8.8	-1.1	8.7

All voltages are in V.

### BX BOARD TRANSISTOR VOLTAGE LIST

	B	C	E
Q3701	1.5	GND	2.2
Q3702	0.1	GND	8.8
Q3703	2.3	8.6	1.7
Q3707	4.2	8.6	3.6
Q3708	0.5	GND	1.2
Q3709	1	GND	1.7
Q3719	3	5	2.3
Q3724	2.4	7.7	1.8
Q3725	7.7	4.5	8.4
Q3728	5.1	GND	5.8
Q3729	4.5	GND	5.2
Q3731	2.4	7.7	1.7
Q3732	7.7	5.1	8.4
Q3733	0	0.1	GND
Q3734	0.1	0	GND

All voltages are in V.

### AX BOARD TRANSISTOR VOLTAGE LIST

	B	C	E
Q101	5.8	8.7	5.1
Q103	4.1	4.7	4.8
Q104	4.8	0	4.8
Q105	4.8	1	4.8
Q106	4.7	8.7	4
Q1902	4.8	0	0
Q1903	4.8	0	0
Q1918	4.8	0	0

All voltages are in V.

### WA BOARD TRANSISTOR VOLTAGE LIST

	B	C	E
Q943	3.1	11.6	2.4
Q944	2.5	11.6	1.9
Q945	2.5	8.1	1.9
Q946	134.3	67.2	134.9
Q947	0.9	67.2	0.4
Q961	0.4	0.7	GND
Q962	0.5	GND	1.1
Q963	6.1	GND	6.2
Q966	8.1	GND	8.4
Q967	6.1	6	6.8
Q968	8.7	11.6	8.3
Q969	5.5	11.3	6
Q981	0	4.7	GND
Q1961	0	0	11.6
	D	G	S
Q965	0.7	6.2	GND

All voltages are in V.

### G BOARD TRANSISTOR VOLTAGE LIST

	B	C	E
Q622	0.3	1.4	GND
Q623	0.7	0	GND
Q624	12.7	0	12.4
Q644	0	11.9	GND
Q645	12.3	GND	9.2
Q646	5.7	6.3	6.3
Q647	0	12.4	GND
Q648	0.6	0.1	GND
Q649	12	0	12
Q650	0	2.4	0
Q651	135	0	135
Q652	3.6	0	3.6
Q653	0	3.6	GND
	D	G	S
Q621	151	1.4	0

All voltages are in V.

### A BOARD TRANSISTOR VOLTAGE LIST

	B	C	E
Q001	4.9	0.7	4.8
Q002	4.9	9.5	4.2
Q003	0	3.9	GND
Q004	0.7	GND	1.2
Q005	0	4.8	0
Q010	0	9.5	0
Q011	0	9.5	0
Q012	0	9.5	0
Q013	0	0	GND
Q014	0	0	GND
Q015	0	0	GND
Q016	5.8	9.5	5.2
Q017	4.2	4.8	4.8
Q304	1.7	GND	2.4
Q305	1.7	GND	2.3
Q306	1.7	GND	2.3
Q351	6.7	9.2	6
Q354	0.2	GND	-0.3
Q356	5.1	GND	5.7
Q357	3.7	9.5	3.1
Q358	2.2	9.1	2.3
Q359	1.1	GND	1.9
Q360	0.2	11.6	0.7
Q361	7.6	11.6	6.9
Q362	3.2	10.8	2.6
Q363	10.8	5	11.4
Q364	5	GND	5.6
Q365	5	9.2	4.4
Q366	2.5	8.5	1.9
Q367	8.5	3.4	9.1
Q368	3.4	GND	4
Q369	3.6	9.2	2.9
Q370	1.9	11.6	1.4
Q501	-0.9	97	GND
Q502	0	134	GND
Q503	0	8.3	GND
Q504	-0.9	0	GND
Q507	0.7	0	GND
Q511	-14	-11	-14.2
Q512	-14.4	19.8	-14.2
Q561	0	3	GND
Q562	-0.2	0	GND
Q1001	0.2	2.2	GND
Q1102	5.7	8.9	5.1
Q1103	0	7.1	GND
Q1351	0.6	9.2	0.4
Q1352	-1.1	10.4	GND
Q1353	11.6	0.6	11.6
Q1354	-0.2	0	GND

All voltages are in V.

### K BOARD TRANSISTOR VOLTAGE LIST

	B	C	E
Q1461	0.7	0	GND
Q1462	0	11.5	GND
Q1463	0	0	GND
Q1464	0	0	GND

All voltages are in V.

### C BOARD TRANSISTOR VOLTAGE LIST

	B	C	E
Q1761	4.1	0.1	3.5

All voltages are in V.

### PX BOARD TRANSISTOR VOLTAGE LIST

	B	C	E
Q3301	2.9	GND	3.6
Q3302	3.3	GND	3.9
Q3303	2.9	GND	3.6
Q3305	5.8	GND	6.4
Q3306	5	GND	5.7
Q3307	5	GND	5.7
Q3308	0	5.8	GND
Q3309	0	5.8	GND
Q3310	0	9	0
Q3311	0	9	0
Q3318	1.3	GND	2
Q3319	0.5	GND	1.2
Q3320	1.3	GND	2
Q3325	3	GND	3.7
Q3326	2.9	GND	3.6
Q3327	2.9	GND	3.6
Q3330	4.9	GND	5.4
Q3333	5	GND	5.6
Q3339	0	5.7	GND
Q3342	0	9	0
Q3343	1.6	GND	2.3
Q3344	0.8	1	GND
Q3345	-0.5	1.4	GND
Q3346	0.8	9	0.6
Q3347	0.8	9	0.6
Q3451	5.1	8.2	6.6

All voltages are in V.

### UX BOARD TRANSISTOR VOLTAGE LIST

	B	C	E
Q202	2.8	7.8	2.2
Q203	2.6	7.8	2.2
Q205	7.8	4	8.3
Q206	7.8	4	8.3
Q208	4.4	8.8	3.5
Q209	4	8.8	3.5
Q210	2.8	7.8	2.2
Q211	7.8	4.1	8.4
Q212	4.1	8.8	3.4
Q231	-0.7	5	GND
Q233	-1.1	0	GND
Q234	-1.1	0	GND
Q235	0	0	GND
Q236	0	0	GND
Q237	4.3	GND	5.1
Q238	4.5	GND	5.1
Q239	4.5	GND	5.1
Q240	-0.2	5.1	GND
Q241	-0.3	5.1	GND
Q242	-0.3	5.1	GND
Q243	4.4	GND	5.1
Q244	4.4	GND	5.1
Q245	4.4	GND	5.1
Q246	0	5.1	GND
Q262	4.4	GND	5
Q263	4.3	GND	5
Q264	4.4	GND	5
Q265	4.7	8.8	4.1
Q266	4.4	GND	5
Q267	0.2	GND	0.9
Q268	8.1	GND	8.8
Q1051	8.8	-1.1	8.7

All voltages are in V.

### BX BOARD TRANSISTOR VOLTAGE LIST

	B	C	E
Q3701	1.5	GND	2.2
Q3702	0.1	GND	8.8
Q3703	2.3	8.6	1.7
Q3707	4.2	8.6	3.6
Q3708	0.5	GND	1.2
Q3709	1	GND	1.7
Q3719	3	5	2.3
Q3724	2.4	7.7	1.8
Q3725	7.7	4.5	8.4
Q3728	5.1	GND	5.8
Q3729	4.5	GND	5.2
Q3731	2.4	7.7	1.7
Q3732	7.7	5.1	8.4
Q3733	0	0.1	GND
Q3734	0.1	0	GND

All voltages are in V.

### AX BOARD TRANSISTOR VOLTAGE LIST

	B	C	E
Q101	5.8	8.7	5.1
Q103	4.1	4.7	4.8
Q104	4.8	0	4.8
Q105	4.8	1	4.8
Q106	4.7	8.7	4
Q1902	4.8	0	0
Q1903	4.8	0	0
Q1918	4.8	0	0

All voltages are in V.

### WA BOARD TRANSISTOR VOLTAGE LIST

	B	C	E
Q943	3.1	11.6	2.4
Q944	2.5	11.6	1.9
Q945	2.5	8.1	1.9
Q946	134.3	67.2	134.9
Q947	0.9	67.2	0.4
Q961	0.4	0.7	GND
Q962	0.5	GND	1.1
Q963	6.1	GND	6.2
Q966	8.1	GND	8.4
Q967	6.1	6	6.8
Q968	8.7	11.6	8.3
Q969	5.5	11.3	6
Q981	0	4.7	GND
Q1961	0	0	11.6
	D	G	S
Q965	0.7	6.2	GND

All voltages are in V.

### G BOARD TRANSISTOR VOLTAGE LIST

	B	C	E
Q622	0.3	1.4	GND
Q623	0.7	0	GND
Q624	12.7	0	12.4
Q644	0	11.9	GND
Q645	12.3	GND	9.2
Q646	5.7	6.3	6.3
Q647	0	12.4	GND
Q648	0.6	0.1	GND
Q649	12	0	12
Q650	0	2.4	0
Q651	135	0	135
Q652	3.6	0	3.6
Q653	0	3.6	GND
	D	G	S
Q621	151	1.4	0

All voltages are in V.

### A BOARD IC VOLTAGE LIST

IC001		4	GND	13	0.1
pin	volt	5	4.1	14	GND
1	0	6	4	15	2.5
2	4.8	7	GND	16	5.5
3	NC	8	4.8	17	4.6
4	NC	IC351		18	0.1
5	NC	pin	volt	19	6.3
6	4.7	1	2.1	20	GND
7	0.1	2	5.6	21	5.9
8	0.1	3	4.1	22	5.9
9	NC	4	4.6	23	5.9
10	NC	5	4	24	9.2
11	NC	6	9.1	IC353	
12	4.8	7	4	pin	volt
13	3.9	8	4	1	4.5
14	1.2	9	0.3	2	3.7
15	4.8	10	6.6	3	4.3
16	GND	11	6.3	4	4.5
17	2.3	12	6.3	5	GND
18	*	13	GND	6	NC
19	0	14	0	7	4.5
20	4.8	15	0	8	NC
21	1.9	16	5.1	9	NC
22	2.2	17	5.1	10	0.9
23	0	18	5.1	11	4
24	0	19	4.8	12	4
25	GND	20	1.7	13	GND
26	1.6	21	4.7	14	11.3
27	2.6	22	1.6	15	5.5
28	2.2	23	4.9	16	11.6
29	4.8	24	1.7	17	7.6
30	0	25	3.5	18	0.6
31	0	26	3.4	19	NC
32	0	27	9	20	NC
33	4.7	28	0.7	IC501	
34	NC	29	3.1	pin	volt
35	NC	30	3.1	1	3.5
36	0.4	31	3.8	2	1.3
37	0	32	4.4	3	8.4
38	0	IC351		4	-14.3
39	0	pin	volt	5	2.3
40	0	1	4.8	6	3
41	0	2	9.2	7	-14.1
42	0	3	3.6	8	14.6
43	0	4	3.5	IC561	
44	2.7	5	4.3	pin	volt
45	2.8	6	4.3	1	1.3
46	4.8	7	2.5	2	14.6
47	4.8	8	GND	3	-12.8
48	GND	9	2.7	4	-14.3
49	GND	10	2.7	5	-0.1
50	4.8	11	4	6	14.8
51	0	12	3.2	7	1.2
52	0	13	6.2	IC1001	
53	4	14	0.8	pin	volt
54	4	15	0	1	0.2
55	4	16	GND	2	0.1
56	4	IC352		3	0.3
57	4.8	pin	volt	4	0.3
58	0.1	1	6	5	5.5
59	3.9	2	5.9	6	4.6
60	3.9	3	5.9	7	4.7
61	0	4	GND	8	GND
62	4.6	5	1.9	9	9.4
63	0.5	6	1.6	10	0
64	4.5	7	9.2	11	GND
IC002		8	3.9	12	GND
pin	volt	9	4	13	GND
1	GND	10	3.8	14	4
2	GND	11	9.2	15	4
3	GND	12	3.6	16	9.4

All voltages are in V.

PIN 18 (I.C.001)\* :CAN NOT BE MEASURED

### AX BOARD IC VOLTAGE LIST

IC1901	
pin	volt
1	0
2	0
3	NC
4	NC
5	NC
6	NC
7	0.3
8	GND
9	0
10	NC
11	8.8
12	GND
13	GND
14	4.3
15	4.3
16	8.8
IC1902	
pin	volt
1	4.8
2	4.5
3	4.8
4	0.1
5	GND
6	0
7	0
8	0
9	0
10	0
11	0
12	NC
13	0
14	NC
15	1.2
16	GND

All voltages are in V.

### G BOARD IC VOLTAGE LIST

IC622	
pin	volt
1	6.2
2	GND
3	4.9
IC641	
pin	volt
1	12.1
2	0.5
3	9.7
IC643	
pin	volt
1	134
2	NC
3	2.5
4	9.2
5	GND
IC650	
pin	volt
1	13.4
2	GND
3	12
IC651	
pin	volt
1	10.5
2	GND
3	5
IC601	
pin	volt
C1	152
C2	298
B2	151
B1	-1.1
E1	GND
E2	152

All voltages are in V.

### BX BOARD IC VOLTAGE LIST

IC3707		69	NC	IC3708	
pin	volt	70	NC	pin	volt
1	GND	71	NC	1	NC
2	GND	72	NC	2	NC
3	1.3	73	NC	3	NC
4	NC	74	NC	4	NC
5	NC	75	NC	5	3.3
6	0	76	NC	6	GND
7	4.1	77	NC	7	GND
8	4.3	78	NC	8	0.4
9	GND	79	NC	9	1
10	NC	80	GND	10	3.3
11	1.1	81	3.3	11	1.1
12	NC	82	3.3	12	1.1
13	NC	83	0.5	13	1.2
14	NC	84	1	14	1.3
15	NC	85	1	15	0.4
16	NC	86	1	16	0.8
17	NC	87	0.1	17	1.2
18	NC	88	0	18	1.3
19	NC	89	0	19	3.3
20	0.4	90	0.6	20	1.1
21	0.8	91	3.3	21	0.4
22	1.2	92	0.6	22	3.3
23	1.3	93	1.4	23	GND
24	1.1	94	1	24	3.3
25	1.1	95	1.9	25	NC
26	1.1	96	0	26	NC
27	1.2	97	NC	27	NC
28	0.4	98	NC	28	NC
29	0.8	99	0	IC3709	
30	GND	100	3.3	pin	volt
31	3.3	IC3705		1	1.2
32	0.1	pin	volt	2	1.1
33	1.4	1	NC	3	1.1
34	0.9	2	5.1	4	1.1
35	1.1	3	2.6	5	GND
36	1.1	4	3.2	6	GND
37	1.3	5	1	7	GND
38	0.4	6	0	8	0.4
39	0.4	7	3.5	9	1
40	1	8	NC	10	3.3
41	1.1	9	2.4	11	1.3
42	1.3	10	2.7	12	1.2
43	1.1	11	0	13	0.8
44	1.1	12	3	14	0.4
45	1.1	13	3	15	0.4
46	0.4	14	5.1	16	0.8
47	0.8	15	5.1	17	0.1
48	1.2	16	3	18	1.4
49	1.3	17	0	19	3.3
50	3.3	18	0	20	1.1
51	GND	19	GND	21	0.4
52	NC	20	4.3	22	GND
53	NC	21	NC	23	GND
54	NC	22	NC	24	GND
55	NC	23	4.1	25	0.9
56	4	24	GND	26	1.1
57	4	25	5.1	27	1.1
58	0.1	26	3.3	28	1.3
59	GND	27	2.9	IC3702	
60	NC	28	3.9	pin	volt
61	NC	29	3.9	O	5.1
62	NC	30	GND	G	GND
63	NC	31	0	I	8.6
64	NC	32	NC	IC3703	
65	NC	33	1.5	pin	volt
66	NC	34	2.6	O	3.3
67	NC	35	NC	G	GND
68	NC	36	2.6	I	5.1

All voltages are in V.

### HF BOARD IC VOLTAGE LIST

IC2001	
pin	volt
1	4.8
2	4.8
3	GND

All voltages are in V.

**PX BOARD IC VOLTAGE LIST**

IC3304		77	4.8	11	1	5	6.6
pin	volt	78	GND	12	GND	6	GND
1	NC	79	0.5	13	3.3	7	NC
2	1	80	1.6	14	2.1	8	GND
3	GND	81	GND	15	1.4	9	1.7
4	5	82	5	16	1.4	10	NC
5	2.5	83	5	17	1.4	11	8.2
6	1.5	84	GND	18	1.4	12	8.2
7	2.1	85	1	19	1.4	13	6.6
8	1.4	86	0.5	20	5	14	2.3
9	0.6	87	2.4	21	GND	15	GND
10	1	88	1.3	22	1.3	16	GND
11	5	89	0.5	23	1.3	17	NC
12	GND	90	1.3	24	1.3	18	GND
13	GND	91	GND	25	1.3	19	2.9
14	4.8	92	5	26	1.2	20	2.8
15	4.9	93	0	27	3.1	21	6.3
16	GND	94	0.5	28	GND	22	2.3
17	0.4	95	1	29	GND	23	GND
18	GND	96	1.8	30	GND	24	4.2
19	GND	97	GND	31	1	<b>IC3308</b>	
20	GND	98	5	32	1	pin	volt
21	GND	99	5	33	0.8	1	0
22	5	100	GND	34	0.8	2	2.8
23	0.3	<b>IC3302</b>		35	GND	3	3.4
24	0.3	pin	volt	36	0.3	4	2.9
25	0.3	1	2.3	37	0.3	5	2.9
26	0.3	2	4.1	38	0.3	6	GND
27	0.3	3	8.6	39	0.2	7	GND
28	0.3	4	1.8	40	GND	8	GND
29	0.3	5	GND	<b>IC3309</b>		9	0.4
30	0.3	6	2.9	pin	volt	10	0.5
31	5	7	2.9	1	2.3	11	0.5
32	0.8	8	3.2	2	4.1	12	2.8
33	0.8	9	8.7	3	8.6	13	3.5
34	0.5	10	0.8	4	1.9	14	2.9
35	0.8	11	4.5	5	GND	15	3
36	1	12	4.4	6	2.9	16	9
37	1	13	4.4	7	2.9	<b>IC3301</b>	
38	1	14	0.3	8	2.8	pin	volt
39	1	15	0.8	9	8.6	1	0.2
40	0	16	0.8	10	0.7	2	0
41	GND	17	GND	11	2.9	3	3.3
42	4.8	18	3.2	12	4.3	4	2.9
43	5	19	2.8	13	4.3	5	2.9
44	GND	20	2.8	14	0.2	6	GND
45	GND	21	NC	15	0.8	7	GND
46	5	22	NC	16	0.8	8	GND
47	3.3	23	NC	17	GND	9	0
48	2.9	24	NC	18	2.7	10	0
49	2	25	8.6	19	2.8	11	0
50	1.3	26	2.3	20	2.9	12	0
51	1.3	27	NC	21	NC	13	3.5
52	1.3	28	NC	22	NC	14	2.9
53	1.3	29	5.2	23	NC	15	3.2
54	1.3	30	1.5	24	NC	16	9
55	1.3	31	GND	25	8.6	<b>IC3311</b>	
56	1.3	32	5.7	26	2.3	pin	volt
57	1.3	33	3.9	27	NC	1	5
58	1.3	34	4.3	28	NC	2	2
59	GND	35	8.6	29	5.2	3	4.3
60	4.8	36	4.7	30	NC	4	NC
61	4.8	37	4.7	31	GND	5	NC
62	5	38	3.9	32	4.7	6	9
63	GND	39	3.2	33	3.8	7	0
64	0.3	40	2.8	34	3.8	8	GND
65	GND	<b>IC3303</b>		35	GND	<b>CM3301</b>	
66	4.8	pin	volt	36	4.7	pin	volt
67	4.8	1	5	37	4.7	1	4.8
68	GND	2	0	38	3.8	2	GND
69	GND	3	0.3	39	3.1	3	4.7
70	5	4	0.3	40	0.8	4	4.7
71	0.5	5	0.3	<b>IC3310</b>		5	9
72	0.5	6	0.3	pin	volt	<b>IC3306</b>	
73	1.4	7	5	1	GND	pin	volt
74	2.4	8	0.8	2	5	O	5
75	1.4	9	0.5	3	GND	G	GND
76	2.5	10	1	4	2.6	I	9

All voltages are in V.

**UX BOARD IC VOLTAGE LIST**

IC261		46	GND
pin	volt	47	NC
1	4.5	48	GND
2	4.5	49	4.3
3	4.5	50	4.5
4	4.5	51	4.4
5	4.5	52	4.5
6	4.4	53	4.5
7	4.5	54	4.4
8	4.5	55	4.5
9	NC	56	4
10	4.5	57	GND
11	NC	58	4.5
12	0	59	4.5
13	NC	60	4.5
14	4.5	61	4.5
15	4.5	62	4.5
16	4.5	63	4.5
17	NC	64	4.5
18	0	<b>IC1051</b>	
19	4.5	pin	volt
20	4.5	1	0.1
21	4.5	2	0.1
22	4.5	3	0.4
23	4.5	4	NC
24	4.5	5	NC
25	NC	6	NC
26	NC	7	NC
27	NC	8	GND
28	NC	9	0.1
29	NC	10	NC
30	0	11	GND
31	4	12	8.9
32	4	13	GND
33	GND	14	4
34	4.5	15	4
35	4.4	16	8.9
36	"4.5"	<b>IC1402</b>	
37	GND	pin	volt
38	NC	1	4.4
39	8.8	2	4.4
40	NC	3	4.4
41	NC	4	GND
42	4.3	5	4.4
43	NC	6	4.4
44	NC	7	4.4
45	NC	8	8.9

All voltages are in V.

**WA BOARD IC VOLTAGE LIST**

IC961		IC963	
pin	volt	pin	volt
1	4	1	5.6
2	4	2	4.4
3	4	3	4.4
4	4	4	GND
5	9	5	5
6	4.3	6	5
7	GND	7	5
8	NC	8	9
9	NC	<b>IC964</b>	
10	7.7	pin	volt
11	NC	1	5.6
12	6.7	2	4.5
13	NC	3	4.5
14	NC	4	GND
15	2	5	5
16	4	6	5
17	5	7	5
18	NC	8	9
19	3.5	<b>IC981</b>	
20	GND	pin	volt
21	0.6	1	4.7
22	NC	2	4.7
<b>IC962</b>		3	4.7
pin	volt	4	GND
1	0	5	4.7
2	0.9	6	4.7
3	0.9	7	4.7
4	GND	8	11.6
5	0.8	<b>IC965</b>	
6	7.1	pin	volt
7	4.7	O	9.1
8	9	G	GND
		I	11.6

All voltages are in V.

**C BOARD IC VOLTAGE LIST**

IC1761	
pin	volt
1	3.5
2	9.1
3	3.3
4	GND
5	7.1
6	212.6
7	141
8	143
9	140
<b>IC1762</b>	
pin	volt
1	3.5
2	9.1
3	3.3
4	GND
5	6.3
6	212.6
7	148
8	150
9	146
<b>IC1763</b>	
pin	volt
1	3.5
2	9.1
3	3.3
4	GND
5	4.1
6	212.6
7	146
8	148
9	145

All voltages are in V.

### A BOARD LOCATION LIST

DIODE	IC352	D-10	
D001	B-5	IC353	D-11
D002	D-2	IC501	G-2
D003	A-5	IC561	H-6
D004	C-2	IC1001	D-9
D011	A-5	<b>TRAN.</b>	
D012	C-1	Q001	B-5
D013	C-5	Q002	C-4
D014	D-2	Q003	H-1
D015	C-3	Q004	H-1
D353	D-7	Q005	B-5
D356	E-3	Q010	D-4
D360	E-7	Q011	D-4
D362	E-7	Q012	D-3
D363	C-11	Q013	D-3
D368	C-7	Q014	D-3
D501	H-2	Q015	D-3
D502	I-8	Q016	D-2
D503	I-8	Q017	A-5
D504	J-7	Q304	C-7
D505	I-6	Q305	C-7
D506	I-6	Q306	C-7
D507	H-2	Q351	C-11
D510	F-8	Q354	E-7
D511	F-8	Q356	C-4
D512	F-9	Q357	E-4
D513	F-9	Q358	E-7
D515	G-4	Q359	E-13
D516	H-2	Q360	E-12
D518	H-2	Q361	E-11
D519	G-9	Q362	E-12
D520	F-2	Q363	E-12
D521	F-2	Q364	E-12
D522	G-2	Q365	B-12
D530	G-8	Q366	B-10
D531	G-9	Q367	B-10
D534	G-8	Q368	C-9
D561	H-7	Q369	D-10
D1001	C-6	Q370	E-13
D1002	C-7	Q501	I-2
D1003	E-10	Q502	J-9
D1004	E-10	Q503	G-2
D1102	B-10	Q504	G-3
D1103	B-12	Q507	F-9
D1104	A-7	Q511	H-2
D1105	A-7	Q512	F-3
D1301	D-13	Q561	G-5
D1302	D-12	Q562	G-5
D1304	D-12	Q1001	C-6
D1305	D-12	Q1102	B-12
D1306	D-13	Q1103	A-10
<b>IC</b>		Q1351	C-10
IC001	B-3	Q1352	E-13
IC002	C-3	Q1353	D-13
IC351	D-5	Q1354	D-12

### G BOARD LOCATION LIST

DIODE	D651	C-3	
D600	G-1	D652	D-3
D601	D-1	D653	D-5
D602	I-3	D698	G-2
D603	E-3	D699	F-2
D604	E-5	<b>IC</b>	
D606	C-1	IC601	H-4
D607	E-4	IC622	D-1
D608	E-5	IC641	B-4
D612	D-2	IC643	D-3
D613	E-1	IC650	B-2
D614	A-2	IC651	B-1
D621	G-2	<b>TRAN.</b>	
D622	G-2	Q621	F-2
D623	F-2	Q622	G-2
D624	F-2	Q623	E-4
D625	F-1	Q624	C-1
D626	G-2	Q644	A-2
D627	F-1	Q645	E-2
D628	E-1	Q646	D-1
D629	I-5	Q647	D-1
D630	H-4	Q648	A-2
D641	C-2	Q649	B-3
D642	C-3	Q650	B-3
D643	D-4	Q651	E-4
D647	B-4	Q652	E-5
D648	C-4	Q653	E-5

### UX BOARD LOCATION LIST

DIODE	SIDE	LOC.	IC1402	A	A-8	
D201	B	B-5	<b>TRAN.</b>	<b>SIDE</b>	<b>LOC.</b>	
D202	B	B-5	Q202	B	B-4	
D203	B	C-5	Q203	B	C-4	
D204	B	E-5	Q205	B	B-4	
D205	B	E-5	Q206	B	C-4	
D231	B	B-6	Q208	B	B-4	
D232	B	B-6	Q209	B	C-4	
D233	B	B-6	Q210	A	F-6	
D234	B	B-6	Q211	A	F-6	
D235	B	C-5	Q212	A	F-6	
D236	B	D-5	Q231	B	B-3	
D237	B	B-6	Q233	B	C-3	
D238	B	D-5	Q234	B	D-3	
D239	B	D-5	Q235	B	C-2	
D245	B	C-3	Q236	B	D-2	
D246	B	E-2	Q237	A	B-7	
D247	A	F-6	Q238	A	B-7	
D248	B	E-2	Q239	A	B-7	
D249	A	F-6	Q240	B	F-4	
D250	B	F-3	Q241	B	F-4	
D261	B	D-3	Q242	B	F-3	
D902	B	E-2	Q243	B	E-3	
D910	B	E-6	Q244	B	E-3	
D911	B	E-6	Q245	B	E-3	
D912	B	E-5	Q246	B	B-3	
D1051	B	B-1	Q262	A	C-6	
D1052	B	A-2	Q263	B	A-3	
D2201	B	F-5	Q264	A	B-6	
D2202	B	F-5	Q265	A	E-6	
D2203	B	F-5	Q266	B	D-3	
<b>IC</b>		<b>SIDE</b>	<b>LOC.</b>	Q267	A	F-7
IC261	A	D-4	Q268	A	B-8	
IC1051	A	B-2	Q1051	B	A-2	

### K BOARD IC VOLTAGE LIST

IC5201		38	NC	77	4.9	14	NC
pin	volt	39	NC	78	4.9	15	4
1	NC	40	NC	79	4.9	16	GND
2	GND	41	NC	80	GND	17	3.8
3	GND	42	NC	81	GND	18	3.8
4	GND	43	NC	82	GND	19	1.8
5	2.6	44	GND	83	4.9	20	1.8
6	2.6	45	NC	84	GND	21	0
7	4.9	46	NC	85	GND	22	0
8	4.9	47	4.9	86	GND	23	4.4
9	2.6	48	NC	87	GND	24	4.4
10	2.6	49	NC	88	GND	25	4.4
11	GND	50	NC	89	GND	26	4.4
12	GND	51	NC	90	4.8	27	4.4
13	NC	52	NC	91	2.4	28	4.4
14	NC	53	NC	92	4.9	29	NC
15	NC	54	GND	93	4.9	30	4.4
16	4.9	55	4.9	94	2.4	31	4.4
17	NC	56	GND	95	4.8	32	5.1
18	NC	57	0.7	96	GND	<b>IC1461</b>	
19	4.9	58	4.9	97	GND	pin	volt
20	NC	59	GND	98	2.1	1	1.6
21	NC	60	GND	99	2.2	2	0
22	NC	61	GND	100	4.9	3	GND
23	GND	62	GND	<b>IC2401</b>		4	0
24	GND	63	GND	pin	volt	5	1.6
25	NC	64	GND	1	GND	6	11.5
26	NC	65	NC	2	4.4	7	16.1
27	NC	66	GND	3	4.4	8	0.9
28	NC	67	GND	4	4.4	9	34.1
29	NC	68	GND	5	NC	10	GND
30	4.9	69	GND	6	4.4	11	0
31	4.9	70	GND	7	4.4	12	15.3
32	NC	71	GND	8	0	<b>IC5202</b>	
33	NC	72	GND	9	4.4	pin	volt
34	NC	73	3.9	10	4.4	1	4.9
35	NC	74	3.9	11	8.8	2	4.9
36	NC	75	GND	12	3.8	3	GND
37	NC	76	4.9	13	4		

All voltages are in V.



# • A BOARD WAVEFORMS

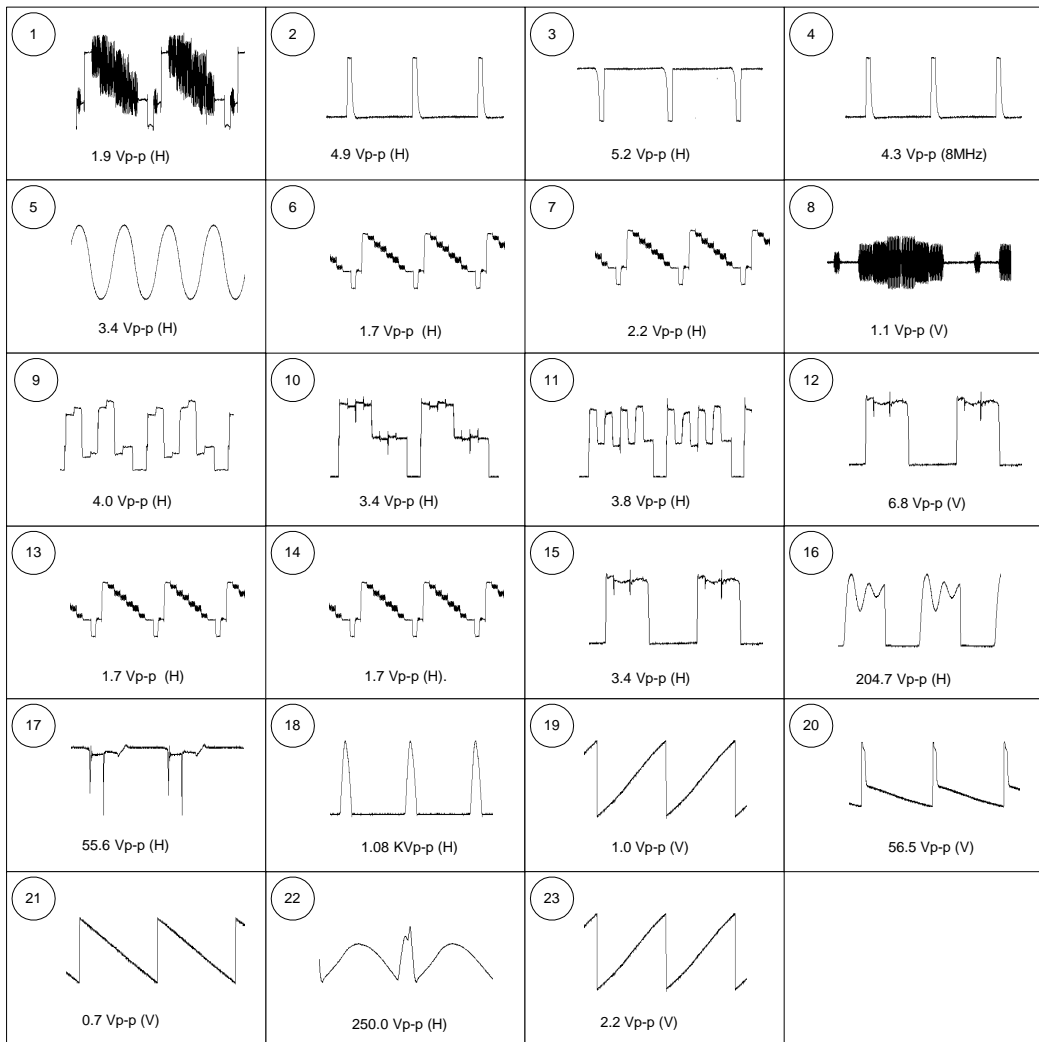

## A BOARD (\*) MARK LIST

PART	LOC.	KV-32XBR200	KV36XBR200
R541	F-10	OXIDE 6.8K 5% 3W	OXIDE 2.2K 5% 3W
R560	F-10	OXIDE 6.8K 5% 3W	OXIDE 2.2K 5% 3W
C550	F-10	680pf 10% 500V	560pf 10% 500V
C553	I-6	0.33MF 5% 200V	0.47MF 5% 200V
C1501	I-7	#	0.1MF 5% 200V

#: NOT MOUNTED

TO BX BOARD  
CN3701

CN102  
11P  
:BTOB-S

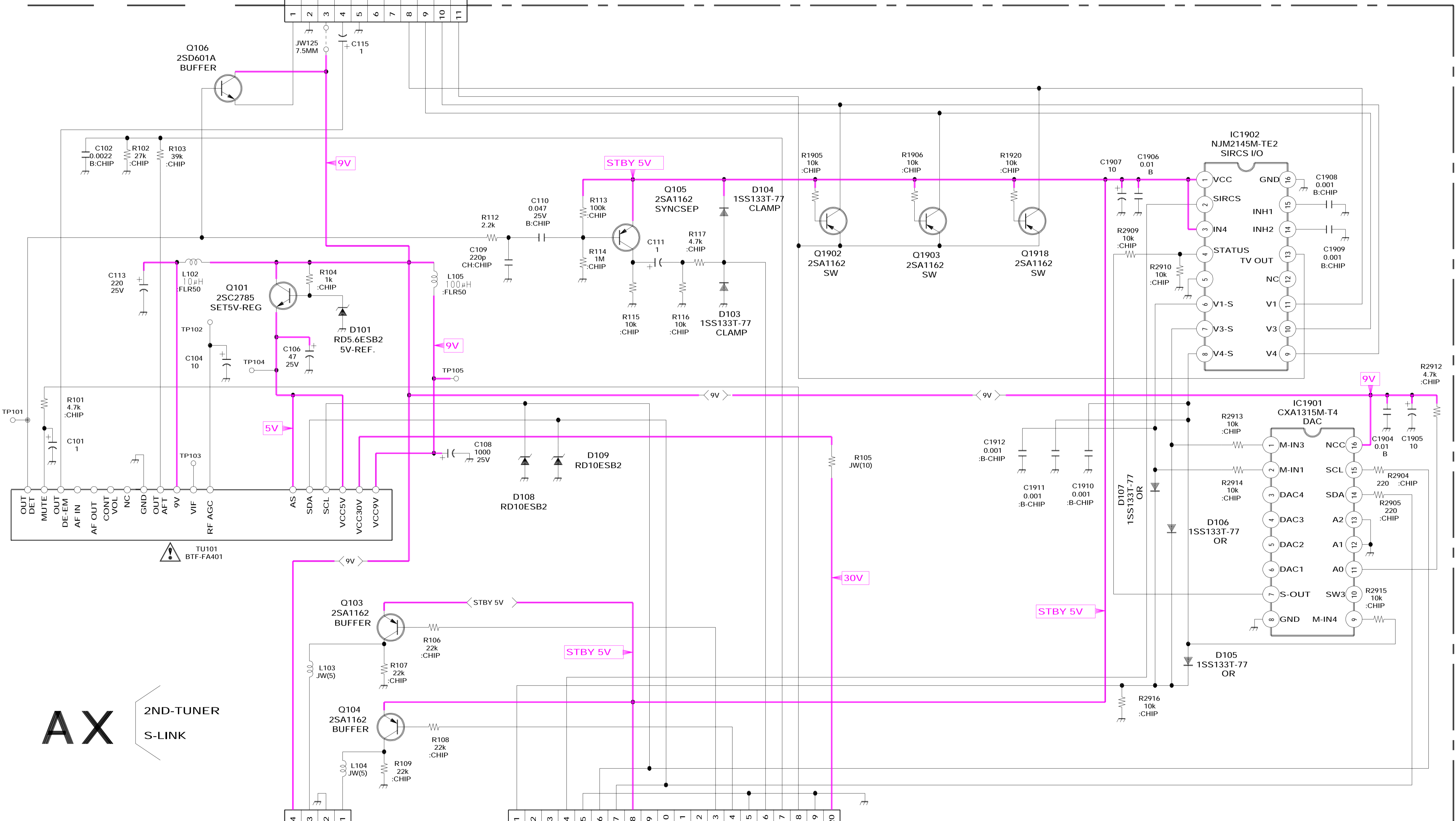

**AX** 2ND-TUNER  
S-LINK

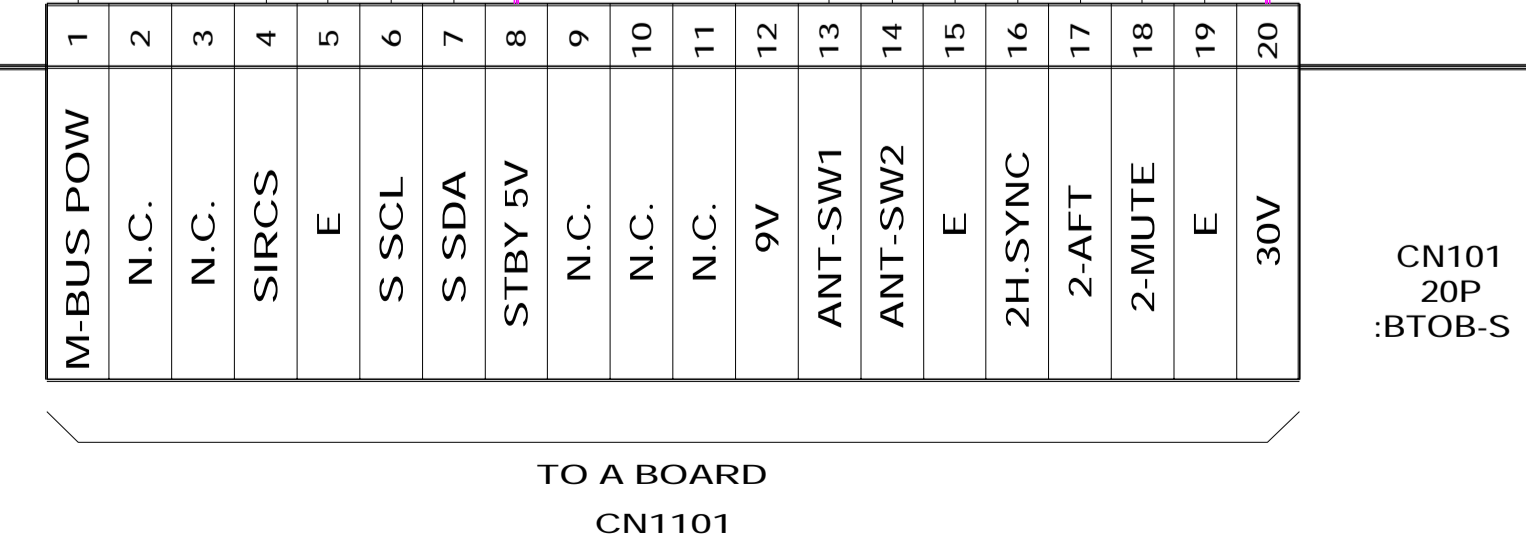
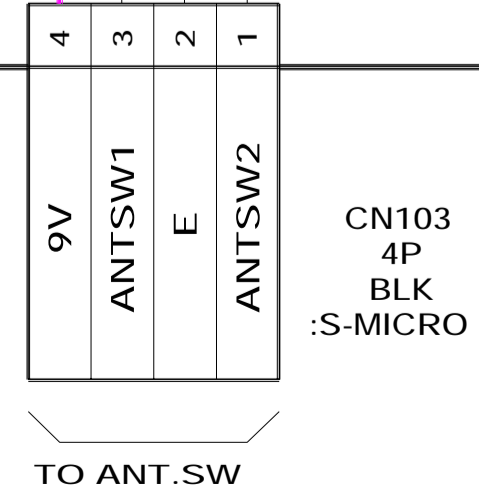

B-SV6900<XBR200>-AX..

# BX

[DIGITAL COMB FILTER]

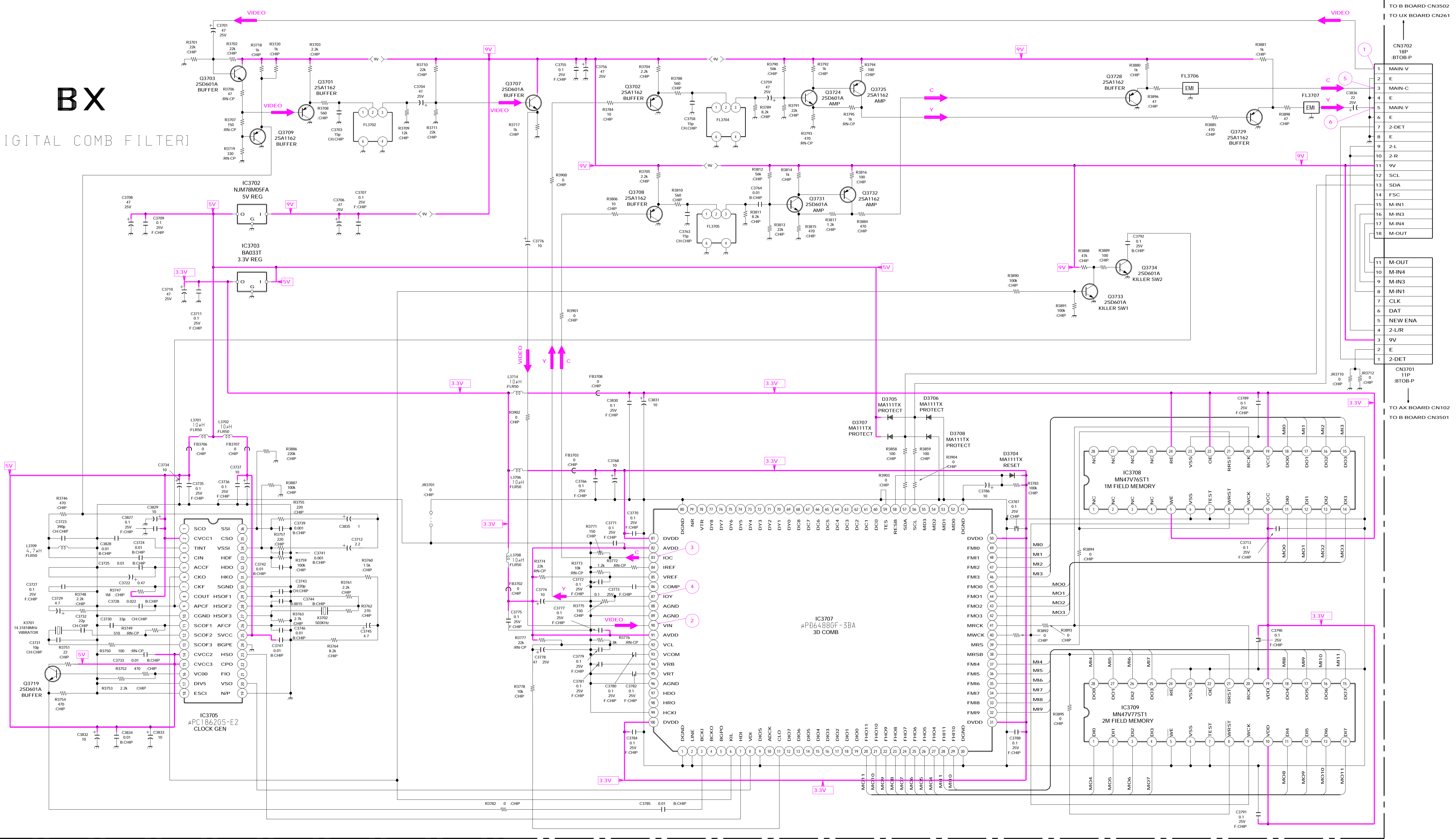

TO B BOARD CN3502  
TO UX BOARD CN261

1	MAIN-V
2	E
3	MAIN-C
4	E
5	MAIN-Y
6	E
7	2-DET
8	E
9	2-L
10	2-R
11	9V
12	SCL
13	SDA
14	FSC
15	M-IN1
16	M-IN3
17	M-IN4
18	M-OUT

TO AX BOARD CN102  
TO B BOARD CN3501

11	M-OUT
10	M-IN4
9	M-IN3
8	M-IN1
7	CLK
6	DAT
5	NEW-ENA
4	2-L/R
3	9V
2	E
1	2-DET

# • BX BOARD WAVEFORMS

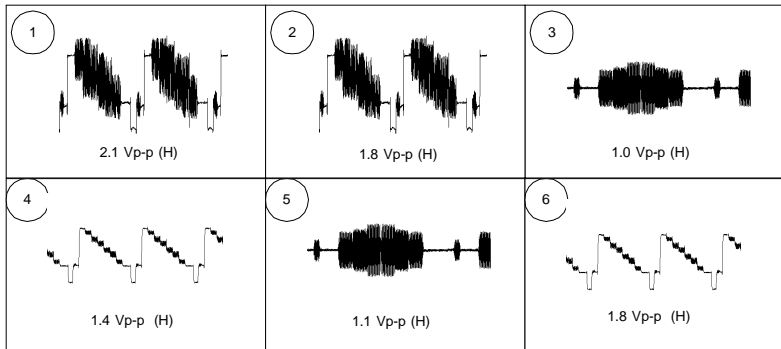

A

B

C

D

E

F

G

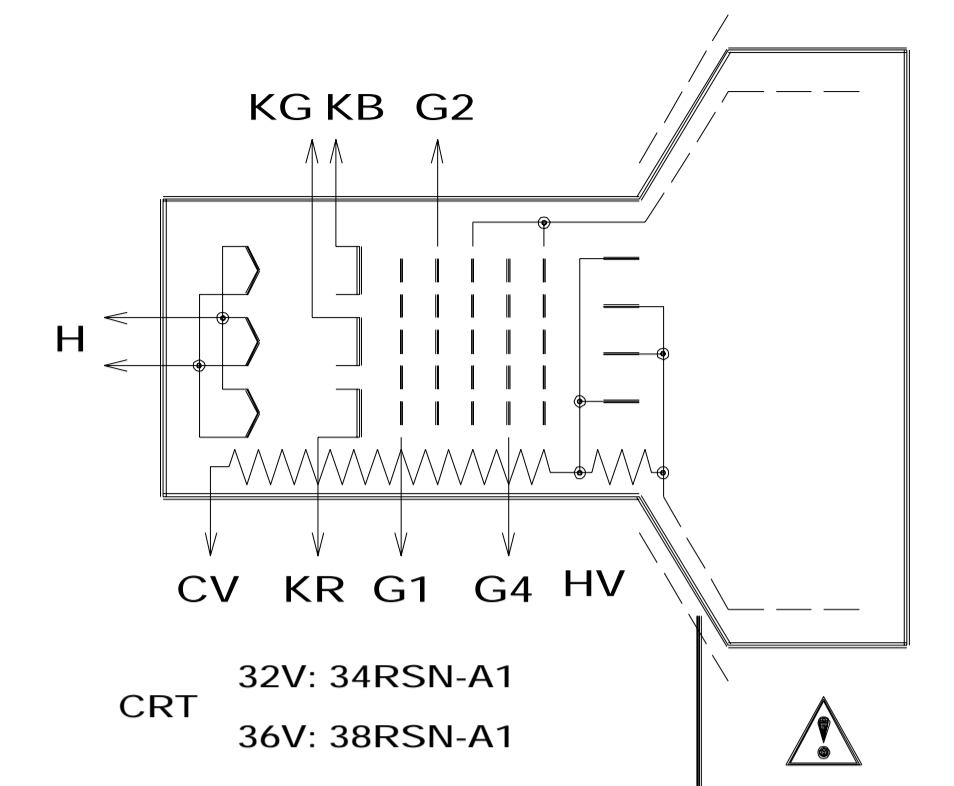
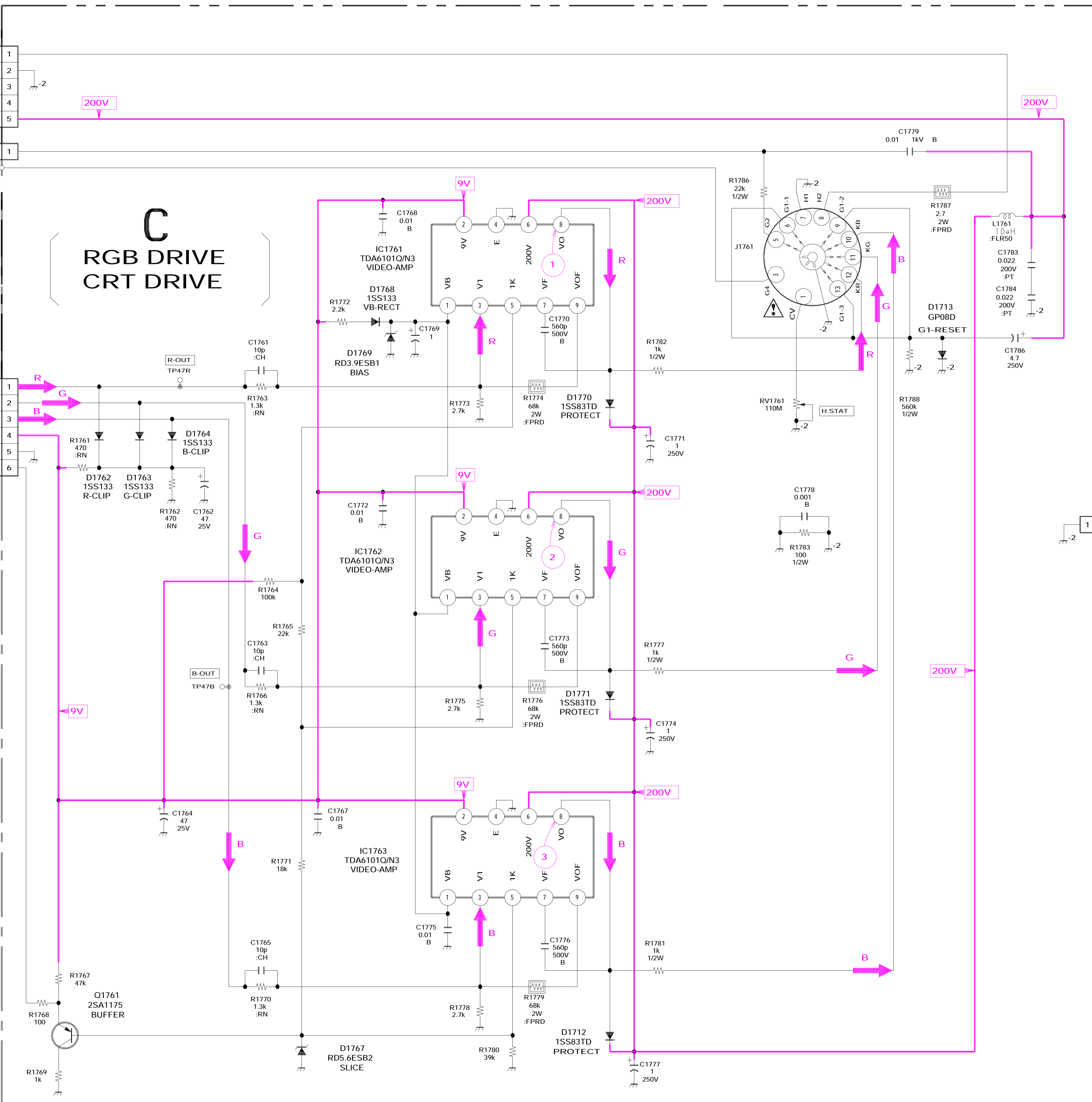
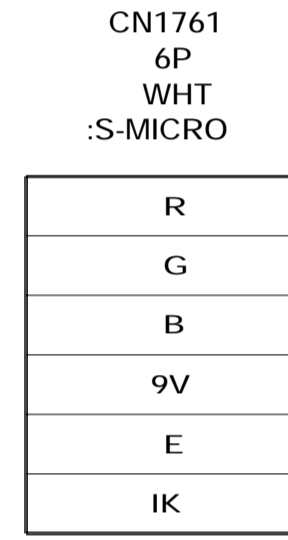
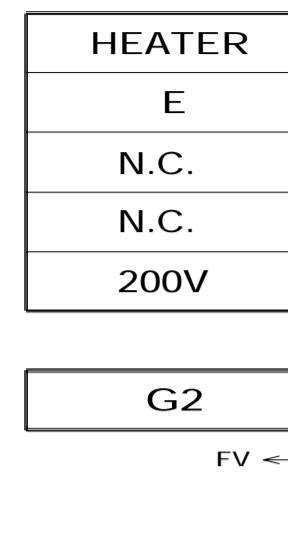
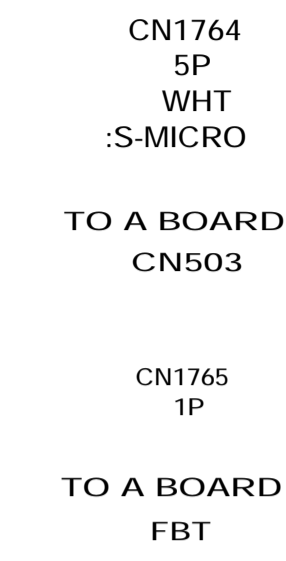

# . C BOARD WAVEFORMS

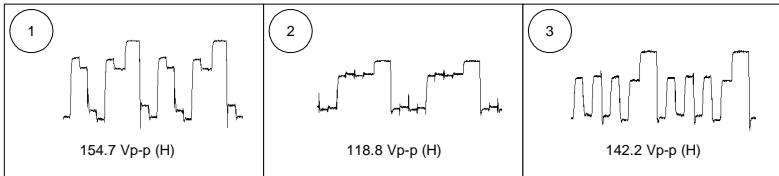

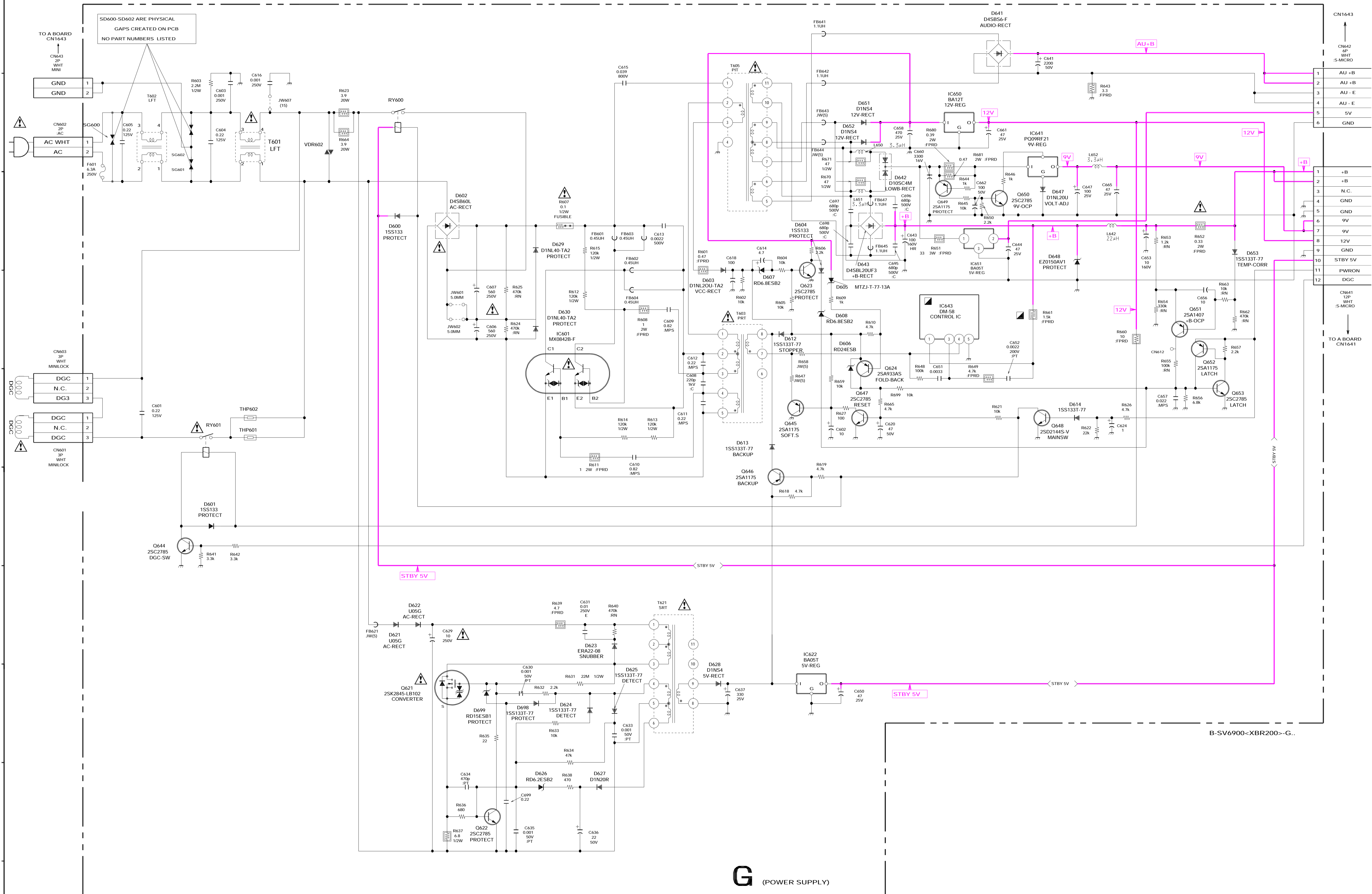

G (POWER SUPPLY)



# HF

[FRONT A/V]  
[IR DETECTOR]

PIN JA CL(L TYPE)  
**FRONT  
VIDEO2**

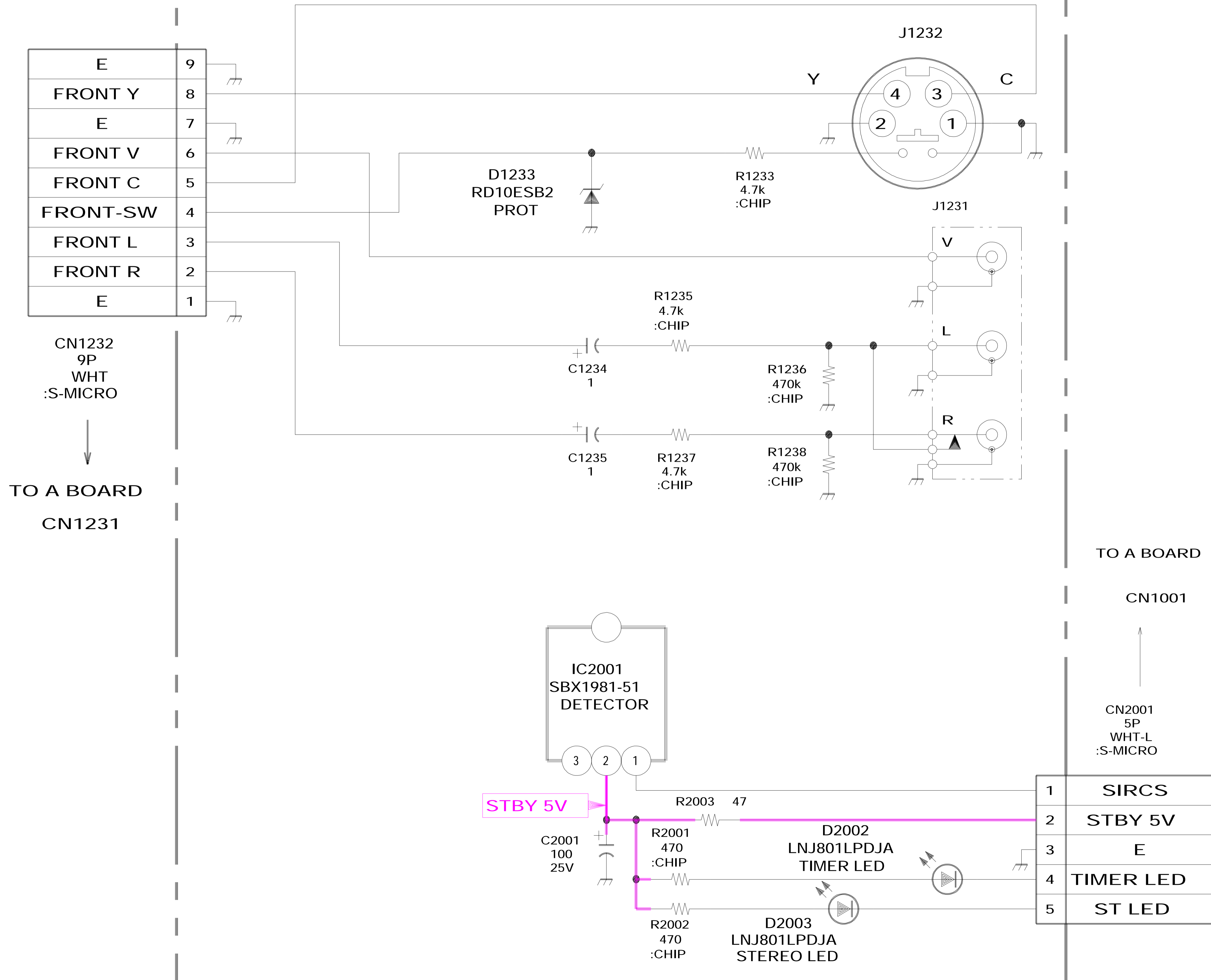

HX

REMOTE SENSOR,  
LED, KEY

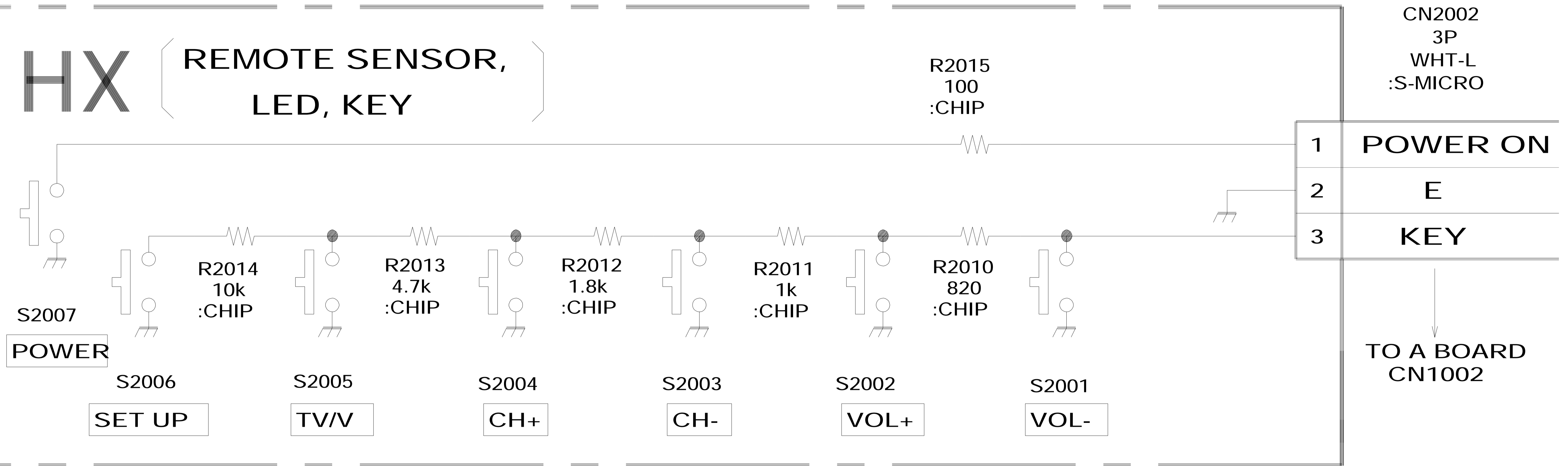

R2015  
100  
:CHIP

CN2002  
3P  
WHT-L  
:S-MICRO

1	POWER ON
2	E
3	KEY

TO A BOARD  
CN1002

B-SV6900<XBR200>-HX..

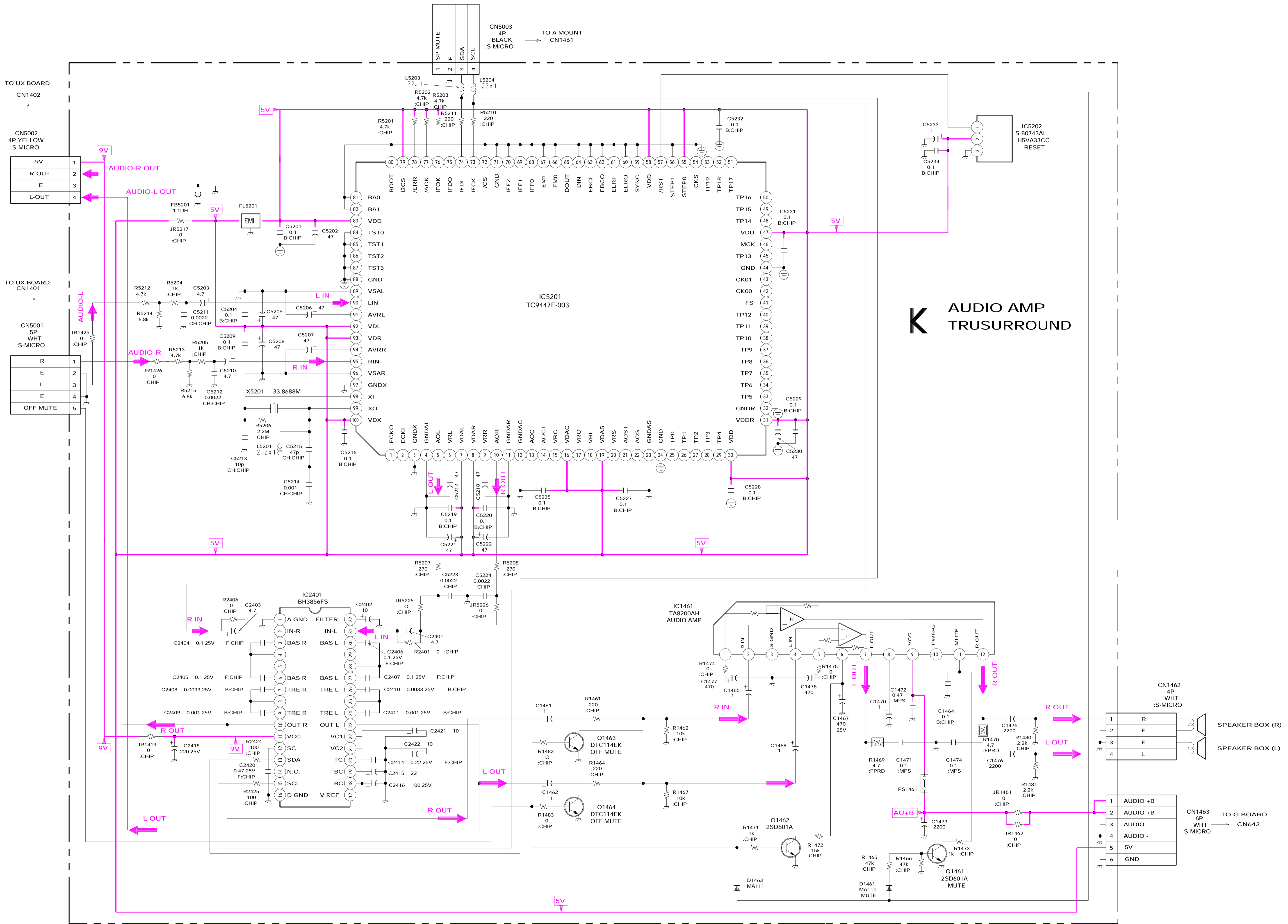

# K AUDIO AMP TRUSURROUND

# PX

[MULTI PIP]

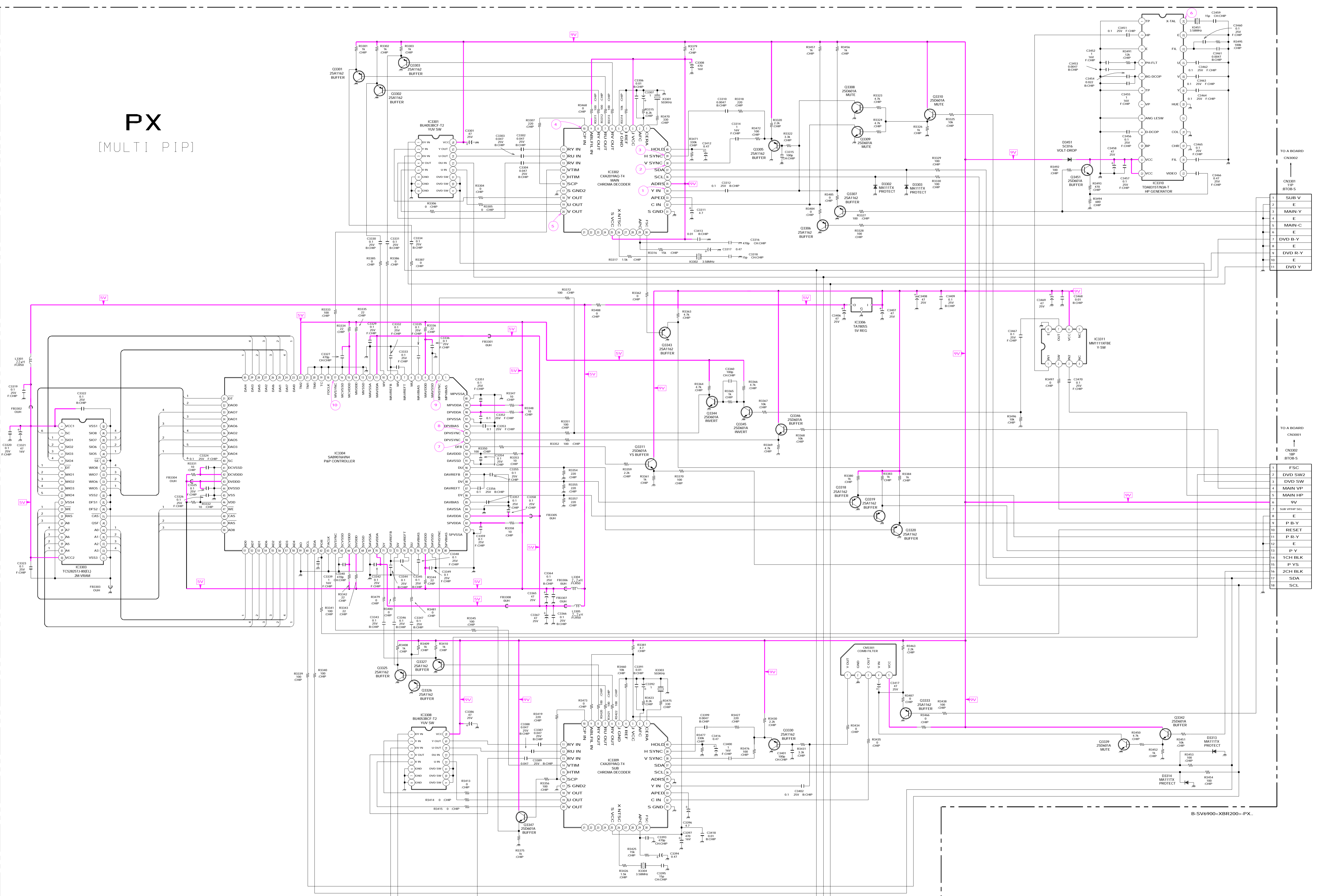

TO A BOARD CN3002

1	SUB V
2	E
3	MAIN Y
4	E
5	MAIN C
6	E
7	DVD B-Y
8	E
9	DVD R-Y
10	E
11	DVD Y

TO A BOARD CN3001

1	FSC
2	DVD SW2
3	DVD SW
4	MAIN VP
5	MAIN HP
6	9V
7	SUB VHP-SCL
8	E
9	P B-Y
10	RESET
11	P R-Y
12	E
13	P Y
14	1CH BLK
15	P YS
16	2CH BLK
17	SDA
18	SCL

# •PX BOARD WAVEFORMS

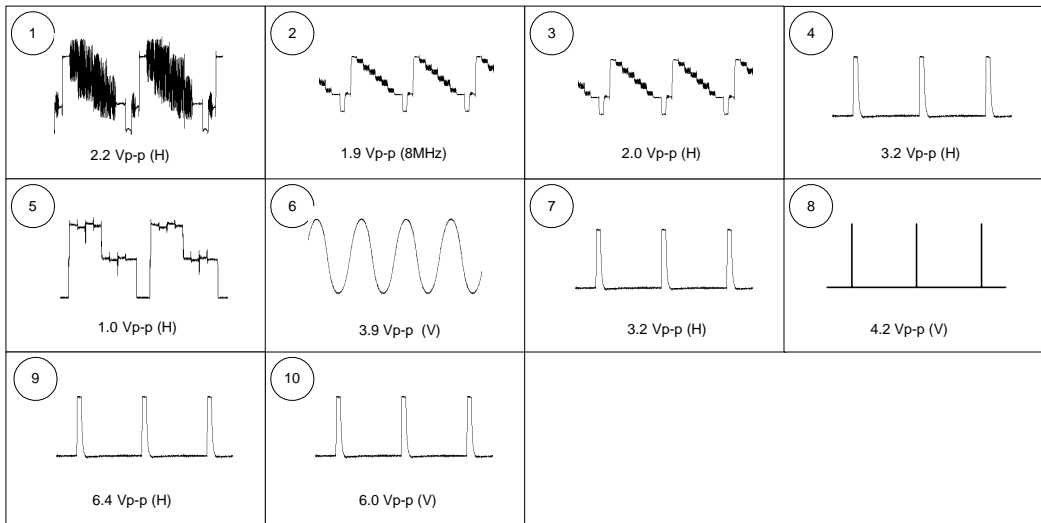

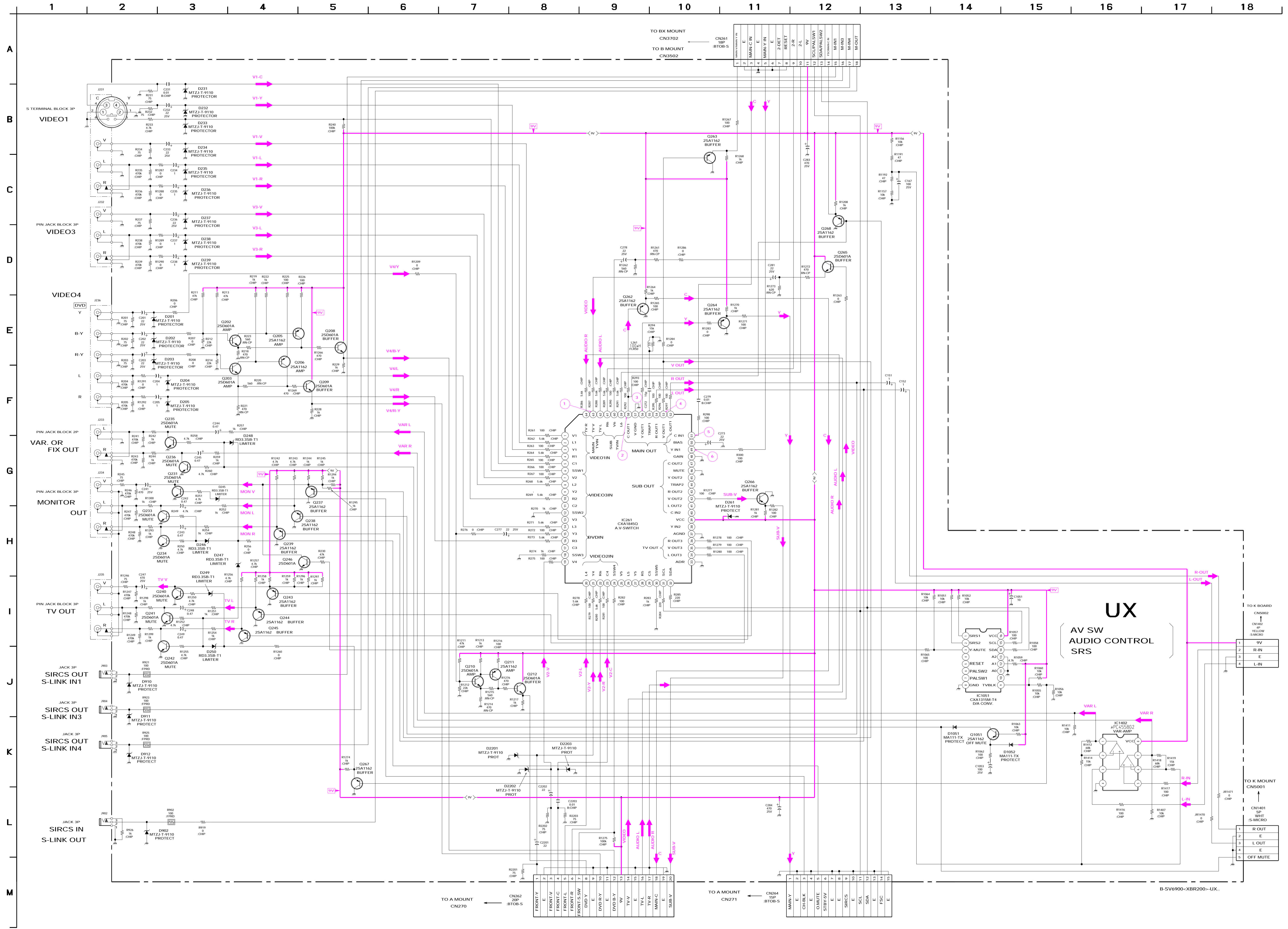

**UX**  
AV SW  
AUDIO CONTROL  
SRS

B-SV6900-XBR200-UX..

# •UX BOARD WAVEFORMS

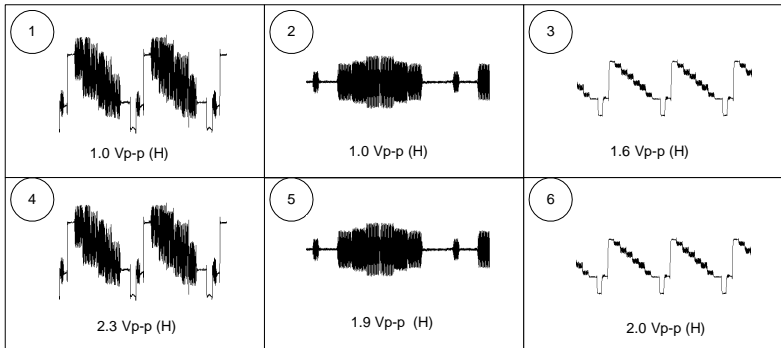

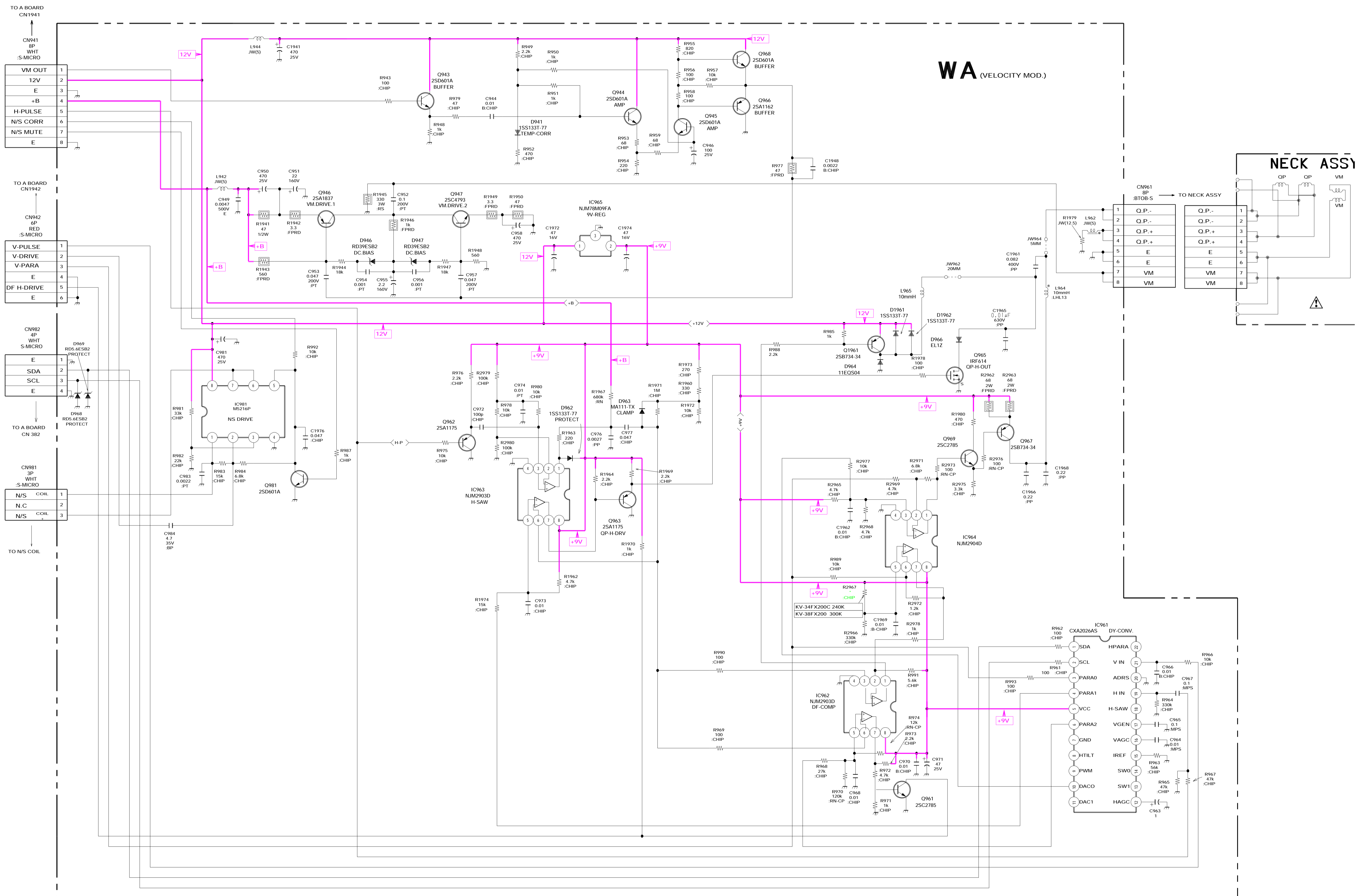



## 6-4. SEMICONDUCTORS

2SA1175-HFE  
2SA933AS-QRT  
2SC2785-HFE

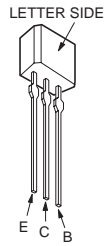

D10SC4MR



2SA1837  
2SC4159-E  
2SC4793  
2SD2012

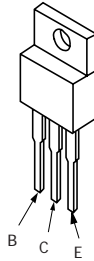

EGP20G  
ERC06-15S

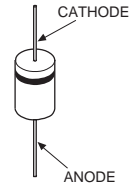

2SA1037K-T146-R  
2SA1162-G  
2SA1330-06  
2SB709A  
2SC1623-L5L6  
2SD601A-Q

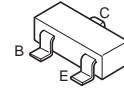

2SC3209LK

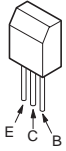

MA111  
RD3.3SB  
1SS355

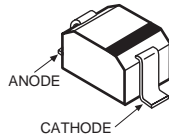

D1NL20  
D2L20U  
EL1Z  
EGP30D  
ERD29-08J  
EZ0150AV1  
GP08D  
MTZJ-T-9110  
MTZJ-33A  
1SS83

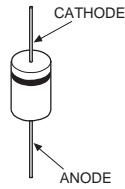

D1NS4  
MTZJ-7.5B  
MTZJ-T-77-13A  
RD10ESB2  
RD33ESB1  
RD3.9ES-B1  
RD3.9ES-B2  
RD5.6ESB2  
RD5.6ESB3  
1SS119-25  
1SS133T-77

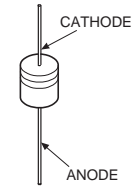

D10SBS4F  
D6SB60L

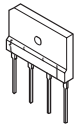

SBX1981-51

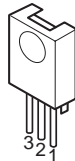

TDA7262

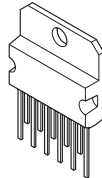

TDA8172

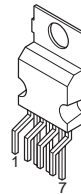

IRF614

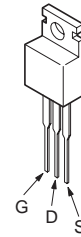

## SECTION 7 EXPLODED VIEWS

• Items with no part number and no description are not stocked because they are seldom required for routine service

• The component parts of an assembly are indicated by the reference numbers in the remarks column.

• Items marked " \* " are not stocked since they are seldom required for routine service. Some delay should be anticipated when ordering these items.

**Note:**

The components identified with gray shading and a critical symbol (  $\Delta$  ) are critical for safety. Replace only with part number specified.

**Note:**

Les composants identifiés par un trame et une marque  $\Delta$  sont critiques pour la sécurité. Ne les remplacer que par une pièce portant le numéro spécifié.

### 7-1. CHASSIS

■	7-685-663-79	SCREW +BVTP 4X16
□	7-685-648-79	SCREW +BVTP 3X12

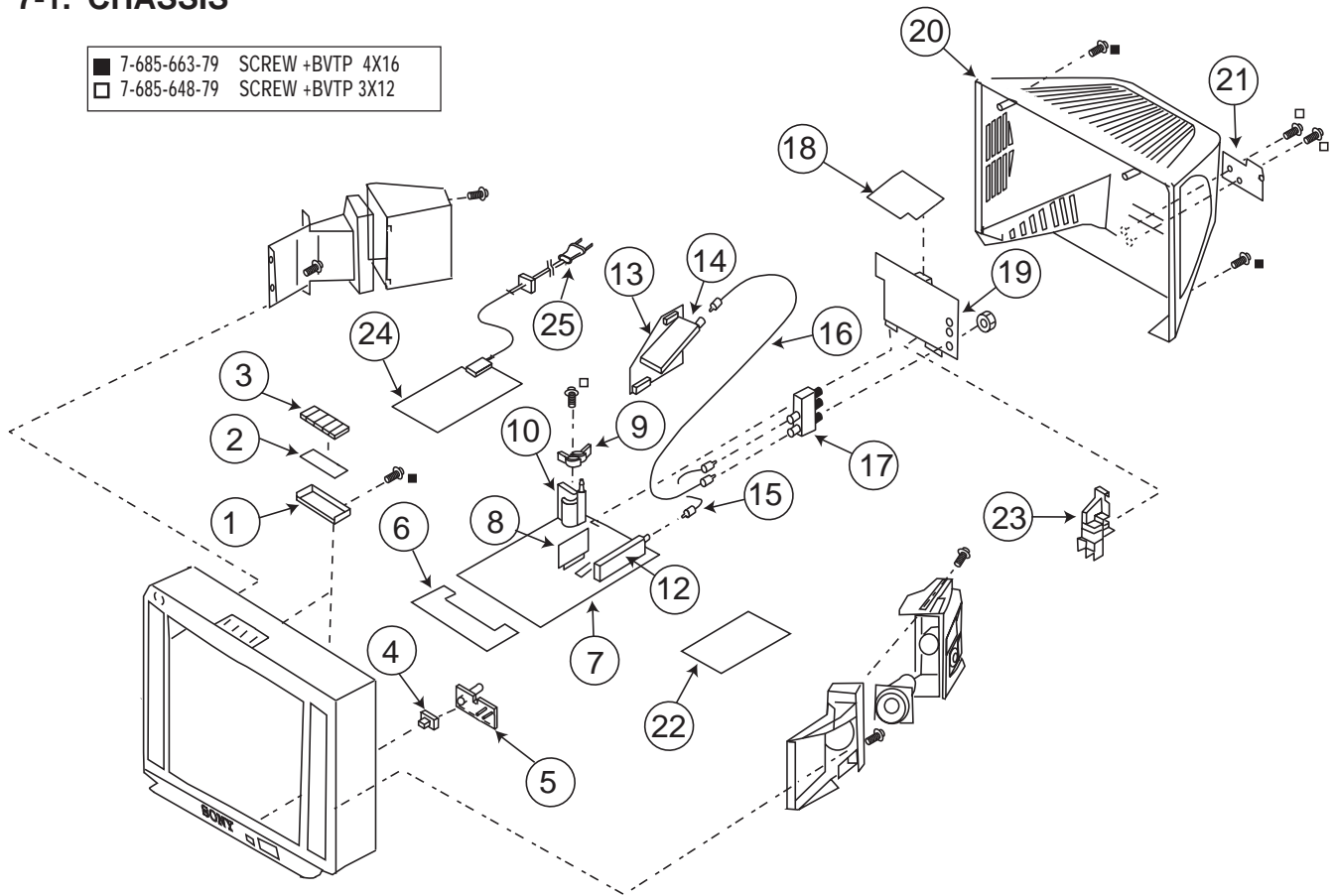

REF.NO.	PART NO.	DESCRIPTION	REMARK	REF.NO.	PART NO.	DESCRIPTION	REMARK
1	4-065-415-01	BRACKET, HX		12	$\Delta$ 8-598-431-00	TUNER, FSS BTF-WA411	
2	A-1372-526-A	HX BOARD, MOUNTED		13	A-1298-641-A	AX BOARD, COMPLETE	
3	4-065-414-01	BUTTON, MULTI		14	$\Delta$ 8-598-430-00	TUNER, FSS BTF-FA401	
4	4-064-809-01	FILTER, REMOTE		15	1-557-056-31	CABLE, P-P	
5	4-064-808-01	GUIDE, LED		16	1-556-945-21	CABLE, P-P	
6	A-1372-520-A	HF BOARD, MOUNTED		17	8-598-414-00	ANTENNA SWITCH AS-2F	
7	A-1298-640-A	A BOARD, COMPLETE (KV-32XBR200)		18	A-1135-902-A	BX BOARD, COMPLETE	
7	A-1298-677-A	A BOARD, COMPLETE (KV-36XBR200)		19	A-1394-907-A	UX BOARD, COMPLETE	
8	A-1195-141-A	PX BOARD, COMPLETE		20	4-064-771-01	COVER, REAR (KV-32XBR200)	
9	4-065-883-01	HOLDER, FBT		20	4-065-905-01	COVER, REAR (KV-36XBR200)	
10	$\Delta$ 1-453-282-11	TRANSFORMER, FLYBACK (NX-4600//X4C) (KV-32XBR200)		21	4-059-500-01	LABEL, ANTENNA	
10	$\Delta$ 1-453-286-11	TRANSFORMER, FLYBACK (NX-4600//X4C4) (KV-36XBR200)		22	A-1385-185-A	K BOARD, COMPLETE	
				23	4-052-905-01	V5/6 BRACKET	
				24	A-1316-397-A	G BOARD, COMPLETE	
				25	$\Delta$ 1-751-059-11	CORD, POWER (WITH CONNECTOR) 10A/125V	

The components identified with gray shading and a critical symbol (△) are critical for safety. Replace only with part number specified.

Les composants identifiés par un triangle et une marque △ sont critiques pour la sécurité. Ne les remplacer que par une pièce portant le numéro spécifié.

## 7-1. PICTURE TUBE REMOVAL

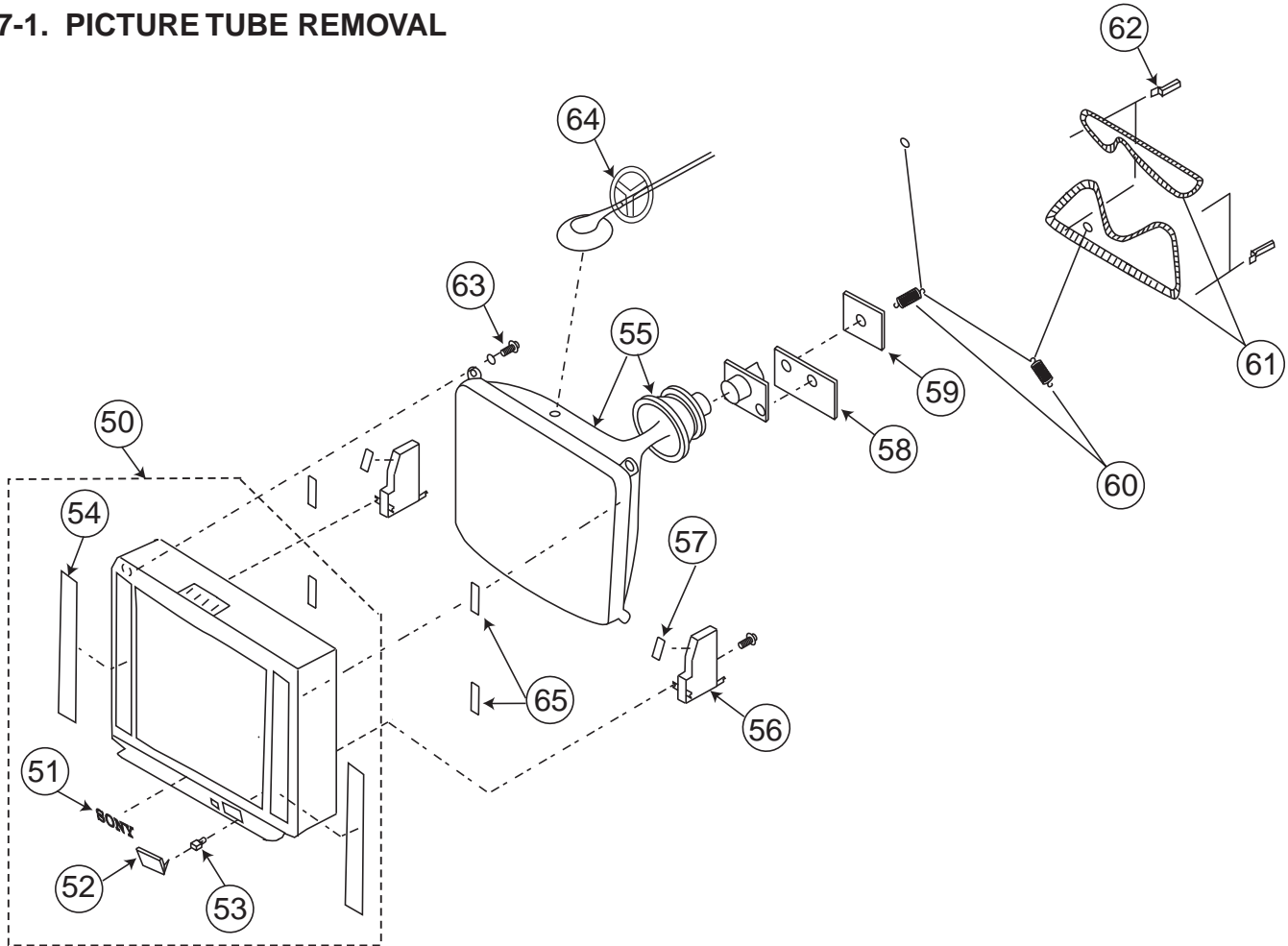

REF.NO.	PART NO.	DESCRIPTION	REMARK
50	X-4035-962-1	BEZNET ASSY (KV-32XBR200)	51-54
50	X-4035-924-1	BEZNET ASSY (KV-36XBR200)	51-54
51	3-704-179-31	EMBLEM(NO.9), SONY	
52	4-064-807-01	DOOR, FRONT TERMINAL	
53	4-042-192-01	CATCHER, PUSH	
54	4-066-291-01	GRILLE, SPEAKER (KV-32XBR200)	
54	4-065-907-01	GRILLE, SPEAKER (KV-36XBR200)	
55	△ 8-735-047-61	ITC 34RSN-A1 (KV-32XBR200)	
55	△ 8-735-048-61	ITC 38RSN-A1 (KV-36XBR200)	
56	4-067-044-01	CRT, SUPPORT (KV-36XBR200)	
57	4-067-050-01	CUSHION, CRT SUPPORT	
58	A-1375-179-A	WA BOARD, MOUNTED (KV-32XBR200)	
58	A-1375-181-A	WA BOARD, MOUNTED (KV-36XBR200)	
59	A-1335-103-A	C BOARD, COMPLETE	
60	4-036-329-01	SPRING (B), TENSION	
61	△ 1-416-827-11	COIL, DEGAUSSING (KV-32XBR200)	
61	△ 1-416-828-11	COIL, DEGAUSSING (KV-36XBR200)	
62	4-065-895-01	HOLDER, DGC	
63	4-046-765-01	SCREW, TAPPING 7 + CROWN WASHER	
64	3-704-372-31	HOLDER, HV CABLE	
65	4-064-378-01	CUSHION (20MM), CRT	

## SECTION 8 ELECTRICAL PARTS LIST

**Note:**

The components identified by shading and mark  $\triangle$  are critical for safety. Replace only with part number specified.

**Note:**

Les composants identifiés par un trame et une marque  $\triangle$  sont critiques pour la sécurité. Ne les remplacer que par une pièce portant le numéro spécifique.

- Items marked " \* " are not stocked since they are seldom required for routine service. Some delay should be anticipated when ordering these items.
- The components identified by  $\boxtimes$  in this manual have been carefully factory-selected for each set in order to satisfy regulations regarding X-ray radiation. Should replacement be required, replace only with the value originally used.
- All variable and adjustable resistors have characteristic curve B, unless otherwise noted.

**RESISTORS**

- All resistors are in ohms
- F : nonflammable

**CAPACITORS**

- MF =  $\mu$ F

**INDUCTORS**

- UH =  $\mu$ H, MMH = mH

When indicating parts by reference number, please include the board name.

REF.NO.	PART NO.	DESCRIPTION	REMARK	REF.NO.	PART NO.	DESCRIPTION	REMARK
		<b>A</b>					
*	A-1298-640-A	A BOARD, COMPLETE (KV-32XBR200)		C355	1-126-959-11	ELECT	0.47MF 20% 50V
*	A-1298-677-A	A BOARD, COMPLETE (KV-36XBR200)		C356	1-126-963-11	ELECT	4.7MF 20% 50V
	4-382-854-11	SCREW (M3X10), P, SW (+)		C357	1-126-959-11	ELECT	0.47MF 20% 50V
	<b>CAPACITOR</b>			C358	1-163-021-91	CERAMIC CHIP	0.01MF 10% 50V
				C359	1-104-665-11	ELECT	100MF 20% 25V
C001	1-163-259-91	CERAMIC CHIP	220PF 5% 50V	C360	1-126-959-11	ELECT	0.47MF 20% 50V
C003	1-163-809-11	CERAMIC CHIP	0.047MF 10% 25V	C361	1-126-959-11	ELECT	0.47MF 20% 50V
C005	1-126-960-11	ELECT	1MF 20% 50V	C362	1-126-959-11	ELECT	0.47MF 20% 50V
C009	1-104-664-11	ELECT	47MF 20% 25V	C363	1-163-021-91	CERAMIC CHIP	0.01MF 10% 50V
C010	1-163-037-11	CERAMIC CHIP	0.022MF 10% 50V	C364	1-163-021-91	CERAMIC CHIP	0.01MF 10% 50V
C012	1-163-010-11	CERAMIC CHIP	0.0012MF 10% 50V	C365	1-163-021-91	CERAMIC CHIP	0.01MF 10% 50V
C013	1-163-038-91	CERAMIC CHIP	0.1MF 25V	C366	1-130-495-00	FILM	0.1MF 5% 50V
C014	1-163-017-00	CERAMIC CHIP	0.0047MF 10% 50V	C367	1-130-495-00	FILM	0.1MF 5% 50V
C023	1-163-259-91	CERAMIC CHIP	220PF 5% 50V	C368	1-130-495-00	FILM	0.1MF 5% 50V
C028	1-163-227-11	CERAMIC CHIP	10PF 0.5PF 50V	C369	1-163-243-11	CERAMIC CHIP	47PF 5% 50V
C029	1-163-227-11	CERAMIC CHIP	10PF 0.5PF 50V	C370	1-163-809-11	CERAMIC CHIP	0.047MF 10% 25V
C030	1-163-009-11	CERAMIC CHIP	0.001MF 10% 50V	C371	1-163-009-11	CERAMIC CHIP	0.001MF 10% 50V
C035	1-163-237-11	CERAMIC CHIP	27PF 5% 50V	C372	1-126-959-11	ELECT	0.47MF 20% 50V
C036	1-163-231-11	CERAMIC CHIP	15PF 5% 50V	C373	1-126-960-11	ELECT	1MF 20% 50V
C037	1-163-243-11	CERAMIC CHIP	47PF 5% 50V	C374	1-164-004-11	CERAMIC CHIP	0.1MF 10% 25V
C038	1-163-243-11	CERAMIC CHIP	47PF 5% 50V	C375	1-164-004-11	CERAMIC CHIP	0.1MF 10% 25V
C039	1-163-243-11	CERAMIC CHIP	47PF 5% 50V	C376	1-126-964-11	ELECT	10MF 20% 50V
C040	1-163-243-11	CERAMIC CHIP	47PF 5% 50V	C377	1-130-495-00	FILM	0.1MF 5% 50V
C051	1-164-161-11	CERAMIC CHIP	0.0022MF 10% 50V	C378	1-136-244-11	FILM	0.1MF 5% 50V
C053	1-163-021-91	CERAMIC CHIP	0.01MF 10% 50V	C379	1-163-021-91	CERAMIC CHIP	0.01MF 10% 50V
C056	1-163-243-11	CERAMIC CHIP	47PF 5% 50V	C380	1-126-942-61	ELECT	1000MF 20% 25V
C061	1-163-037-11	CERAMIC CHIP	0.022MF 10% 50V	C381	1-163-133-00	CERAMIC CHIP	470PF 5% 50V
C062	1-163-037-11	CERAMIC CHIP	0.022MF 10% 50V	C382	1-164-004-11	CERAMIC CHIP	0.1MF 10% 25V
C063	1-126-941-11	ELECT	470MF 20% 25V	C383	1-130-495-00	FILM	0.1MF 5% 50V
C071	1-164-096-11	CERAMIC	0.01MF 50V	C384	1-164-004-11	CERAMIC CHIP	0.1MF 10% 25V
C072	1-164-161-11	CERAMIC CHIP	0.0022MF 10% 50V	C385	1-164-182-11	CERAMIC CHIP	0.0033MF 10% 50V
C075	1-107-823-11	CERAMIC CHIP	0.47MF 10% 16V	C386	1-163-021-91	CERAMIC CHIP	0.01MF 10% 50V
C351	1-163-021-91	CERAMIC CHIP	0.01MF 10% 50V	C387	1-126-961-11	ELECT	2.2MF 20% 50V
C352	1-164-004-11	CERAMIC CHIP	0.1MF 10% 25V	C388	1-126-959-11	ELECT	0.47MF 20% 50V
C353	1-163-231-11	CERAMIC CHIP	15PF 5% 50V	C390	1-126-960-11	ELECT	1MF 20% 50V
C354	1-163-133-00	CERAMIC CHIP	470PF 5% 50V	C391	1-163-017-00	CERAMIC CHIP	0.0047MF 10% 50V
				C392	1-163-251-11	CERAMIC CHIP	100PF 5% 50V
				C393	1-164-004-11	CERAMIC CHIP	0.1MF 10% 25V
				C394	1-164-004-11	CERAMIC CHIP	0.1MF 10% 25V
				C395	1-104-664-11	ELECT	47MF 20% 25V

**A****Note:**

The components identified with shading and a critical symbol  $\Delta$  are critical for safety. Replace only with part number specified.

**Note:**

Les composants identifiés par un trame et une marque  $\Delta$  sont critiques pour la sécurité. Ne les remplacer que par une pièce portant le numéro spécifié.

REF.NO.	PART NO.	DESCRIPTION	REMARK
C397	1-104-664-11	ELECT	47MF 20% 25V
C398	1-126-961-11	ELECT	2.2MF 20% 50V
C501	1-102-110-00	CERAMIC	220PF 10% 50V
C502	1-126-959-11	ELECT	0.47MF 20% 50V
C503	1-163-133-00	CERAMIC CHIP	470PF 5% 50V
C504	1-102-228-00	CERAMIC	470PF 10% 500V
C505	1-102-228-00	CERAMIC	470PF 10% 500V
C506	1-106-383-00	MYLAR	0.047MF 10% 200V
C507 $\Delta$	1-162-116-00	CERAMIC	680PF 10% 2KV
C508	1-102-228-00	CERAMIC	470PF 10% 500V
C509	1-162-116-00	CERAMIC	680PF 10% 2KV
C510	1-137-150-11	MYLAR	0.01MF 10% 100V
C511 $\Delta$	1-137-347-11	FILM	0.022MF 3% 2KV
C512	1-129-928-00	FILM	0.0027MF 10% 630V
C513 $\Delta$	1-130-118-00	FILM	0.051MF 5% 400V
C514 $\Delta$	1-115-521-11	FILM	0.82MF 5% 250V
C515	1-106-343-00	MYLAR	0.001MF 10% 100V
C516	1-136-540-11	FILM	0.82MF 5% 200V
C517	1-107-649-11	ELECT	2.2MF 20% 250V
C518	1-106-395-00	MYLAR	0.068MF 10% 200V
C519	1-162-815-11	CERAMIC	47PF 5% 500V
C520	1-165-136-11	CERAMIC	3300PF 10% 500V
C521	1-163-010-11	CERAMIC CHIP	0.0012MF 10% 50V
C522	1-126-960-11	ELECT	1MF 20% 50V
C525	1-102-244-00	CERAMIC	220PF 10% 500V
C526	1-107-662-11	ELECT	22MF 20% 250V
C527	1-162-116-00	CERAMIC	680PF 10% 2KV
C528	1-164-161-11	CERAMIC CHIP	0.0022MF 10% 50V
C529	1-128-551-11	ELECT	22MF 20% 25V
C530	1-137-366-11	FILM	0.0022MF 5% 50V
C531 $\Delta$	1-126-965-11	ELECT	22MF 20% 50V
C532 $\Delta$	1-126-965-11	ELECT	22MF 20% 50V
C537	1-126-941-11	ELECT	470MF 20% 25V
C539	1-126-941-11	ELECT	470MF 20% 25V
C540	1-104-710-11	ELECT	22MF 0 160V
C541	1-128-560-11	ELECT	22MF 20% 100V
C544	1-129-718-00	FILM	0.022MF 5% 630V
C545	1-106-387-00	MYLAR	0.068MF 10% 200V
C546	1-106-343-00	MYLAR	0.001MF 10% 100V
C547	1-106-343-00	MYLAR	0.001MF 10% 100V
C548	1-164-004-11	CERAMIC CHIP	0.1MF 10% 25V
C549	1-106-375-12	MYLAR	0.022MF 99% 200V
C550	1-102-002-00	CERAMIC	680PF 10% 500V (KV-32XBR200)
C550	1-102-157-00	CERAMIC	560PF 10% 500V (KV-36XBR200)
C551	1-109-954-11	ELECT	0.47MF 20% 160V
C552	1-102-244-00	CERAMIC	220PF 10% 500V

REF.NO.	PART NO.	DESCRIPTION	REMARK
C553	1-117-665-11	FILM	0.33MF 5% 250V (KV-32XBR200)
C553	1-117-667-71	FILM	0.47MF 5% 250V (KV-36XBR200)
C554 $\Delta$	1-115-350-51	CERAMIC	0.0047MF 2KV
C561	1-126-967-11	ELECT	47MF 20% 50V
C563	1-104-666-11	ELECT	220MF 20% 25V
C564	1-126-960-11	ELECT	1MF 20% 50V
C565	1-126-969-11	ELECT	220MF 20% 50V
C568	1-136-169-00	FILM	0.22MF 5% 50V
C571	1-126-941-11	ELECT	470MF 20% 25V
C599	1-126-941-11	ELECT	470MF 20% 25V
C1002	1-126-964-11	ELECT	10MF 20% 50V
C1003	1-126-961-11	ELECT	2.2MF 20% 50V
C1004	1-126-960-11	ELECT	1MF 20% 50V
C1101	1-126-943-11	ELECT	2200MF 20% 25V
C1103	1-126-965-11	ELECT	22MF 20% 50V
C1104	1-104-664-11	ELECT	47MF 20% 25V
C1105	1-104-664-11	ELECT	47MF 20% 25V
C1106	1-126-964-11	ELECT	10MF 20% 50V
C1107	1-163-037-11	CERAMIC CHIP	0.022MF 10% 50V
C1108	1-128-551-11	ELECT	22MF 20% 25V
C1109	1-126-964-11	ELECT	10MF 20% 50V
C1110	1-163-227-11	CERAMIC CHIP	10PF 0.5PF 50V
C1111	1-163-227-11	CERAMIC CHIP	10PF 0.5PF 50V
C1112	1-163-227-11	CERAMIC CHIP	10PF 0.5PF 50V
C1117	1-126-960-11	ELECT	1MF 20% 50V
C1118	1-126-960-11	ELECT	1MF 20% 50V
C1351	1-163-251-11	CERAMIC CHIP	100PF 5% 50V
C1353	1-163-037-11	CERAMIC CHIP	0.022MF 10% 50V
C1355	1-163-009-11	CERAMIC CHIP	0.001MF 10% 50V
C1356	1-126-964-11	ELECT	10MF 20% 50V
C1357	1-107-823-11	CERAMIC CHIP	0.47MF 10% 16V
C1358	1-126-940-11	ELECT	330MF 20% 25V
C1359	1-164-004-11	CERAMIC CHIP	0.1MF 10% 25V
C1360	1-163-021-91	CERAMIC CHIP	0.01MF 10% 50V
C1361	1-163-241-11	CERAMIC CHIP	39PF 5% 50V
C1362	1-163-017-00	CERAMIC CHIP	0.0047MF 10% 50V
C1363	1-163-021-91	CERAMIC CHIP	0.01MF 10% 50V
C1367	1-104-664-11	ELECT	47MF 20% 25V
C1368	1-126-960-11	ELECT	1MF 20% 50V
C1369	1-164-004-11	CERAMIC CHIP	0.1MF 10% 25V
C1370	1-126-964-11	ELECT	10MF 20% 50V
C1371	1-163-017-00	CERAMIC CHIP	0.0047MF 10% 50V
C1372	1-163-017-00	CERAMIC CHIP	0.0047MF 10% 50V
C1373	1-163-133-00	CERAMIC CHIP	470PF 5% 50V
C1501 $\Delta$	1-117-659-71	FILM	0.1MF 5% 200V (KV-36XBR200 ONLY)

**Note:**

The components identified with shading and a critical symbol  $\triangle$  are critical for safety. Replace only with part number specified.

**Note:**

Les composants identifiés par un trame et une marque  $\triangle$  sont critiques pour la sécurité. Ne les remplacer que par une pièce portant le numéro spécifié.



REF.NO.	PART NO.	DESCRIPTION	REMARK	REF.NO.	PART NO.	DESCRIPTION	REMARK
<b>CONNECTOR</b>							
CN270	1-573-298-11	CONNECTOR, BOARD TO BOARD 20P		D516	8-719-991-33	DIODE1SS133T-77	
CN271 *	1-691-616-21	CONNECTOR, BOARD TO BOARD 15P		D518	8-719-991-33	DIODE1SS133T-77	
CN351 *	1-564-509-11	PLUG, CONNECTOR 6P		D519 $\triangle$	8-719-302-43	DIODE EL1Z	
CN382 *	1-564-507-11	PLUG, CONNECTOR 4P		D520 $\triangle$	8-719-991-33	DIODE1SS133T-77	
CN501 *	1-580-798-11	CONNECTOR PIN (DY) 6P		D521 $\triangle$	8-719-921-63	DIODE MTZJ-7.5B	
CN503 *	1-564-508-11	PLUG, CONNECTOR 5P		D522	8-719-991-33	DIODE1SS133T-77	
CN1001 *	1-564-508-11	PLUG, CONNECTOR 5P		D530	8-719-979-85	DIODE EGP20G	
CN1002 *	1-564-506-11	PLUG, CONNECTOR 3P		D531	8-719-979-85	DIODE EGP20G	
CN1101	1-573-298-11	CONNECTOR, BOARD TO BOARD 20P		D534	8-719-302-43	DIODE EL1Z	
CN1231 *	1-564-512-11	PLUG, CONNECTOR 9P		D561	8-719-908-03	DIODE GP08D	
CN1461 *	1-564-507-11	PLUG, CONNECTOR 4P		D1001	8-719-404-49	DIODE MA111	
CN1641 *	1-564-515-11	PLUG, CONNECTOR 12P		D1002	8-719-404-49	DIODE MA111	
CN1643 *	1-508-784-00	PIN, CONNECTOR (5MM PITCH) 1P		D1003	8-719-110-17	DIODE RD10ESB2	
CN1941 *	1-564-511-11	PLUG, CONNECTOR 8P		D1004	8-719-110-17	DIODE RD10ESB2	
CN1942 *	1-564-509-11	PLUG, CONNECTOR 6P		D1102	8-719-982-24	DIODE MTZJ-33A	
CN3001	1-573-297-21	CONNECTOR, BOARD TO BOARD 18P		D1103	8-719-109-89	DIODE RD5.6ESB2	
CN3002	1-573-978-21	CONNECTOR, BOARD TO BOARD 11P		D1104	8-719-110-17	DIODE RD10ESB2	
<b>DIODE</b>							
D001	8-719-991-33	DIODE 1SS133T-77		D1105	8-719-110-17	DIODE RD10ESB2	
D002	8-719-109-89	DIODE RD5.6ESB2		D1301	8-719-404-49	DIODE MA111	
D003	8-719-991-33	DIODE 1SS133T-77		D1302	8-719-991-33	DIODE1SS133T-77	
D004	8-719-110-17	DIODE RD10ESB2		D1304	8-719-991-33	DIODE1SS133T-77	
D011	8-719-109-72	DIODE RD3.9ESB2		D1305	8-719-991-33	DIODE1SS133T-77	
D012	8-719-991-33	DIODE 1SS133T-77		D1306	8-719-404-49	DIODE MA111	
D013	8-719-991-33	DIODE 1SS133T-77		<b>DELAY LINE</b>			
D014	8-719-991-33	DIODE 1SS133T-77		DL351	1-416-231-11	DELAY LINE	
D015	8-719-991-33	DIODE 1SS133T-77		<b>FERRITE BEAD</b>			
D353	8-719-991-33	DIODE 1SS133T-77		FB501	1-410-397-21	FERRITE	1.1UH
D356	8-719-991-33	DIODE 1SS133T-77		FB502	1-410-397-21	FERRITE	1.1UH
D360	8-719-110-17	DIODE RD10ESB2		FB503	1-410-397-21	FERRITE	1.1UH
D362	8-719-991-33	DIODE 1SS133T-77		<b>IC</b>			
D363	8-719-404-49	DIODE MA111		IC001	8-752-886-53	ICXP85856A-001S	
D368	8-719-991-33	DIODE 1SS133T-77		IC002	8-759-353-44	ICST24C08FM6TR	
D501	8-719-109-89	DIODE RD5.6ESB2		IC351 $\triangle$	8-752-082-73	ICXA2095S	
D502	8-719-945-80	DIODE ERC06-15S		IC352	8-752-080-75	ICXA2039M-T6	
D503	8-719-945-80	DIODE ERC06-15S		IC353	8-759-462-91	ICTA1226N	
D504	8-719-900-26	DIODE ERD29-08J		IC501 $\triangle$	8-759-700-07	ICNJM2903M	
D505	8-719-908-03	DIODE GP08D		IC561	8-759-192-71	ICSTV9379	
D506	8-719-908-03	DIODE GP08D		IC1001	8-752-058-68	ICXA1315M	
D507	8-719-991-33	DIODE 1SS133T-77		<b>CHIP CONDUCTOR</b>			
D510	8-719-300-33	DIODE RU-3AM		JR001	1-216-295-91	SHORT	0
D511	8-719-970-87	DIODE ERA38-06		JR002	1-216-295-91	SHORT	0
D512	8-719-970-87	DIODE ERA38-06		JR003	1-216-295-91	SHORT	0
D513	8-719-110-41	DIODE RD15ESB2		JR052	1-216-295-91	SHORT	0
D515	8-719-302-43	DIODE EL1Z		JR053	1-216-295-91	SHORT	0



REF.NO.	PART NO.	DESCRIPTION	REMARK	REF.NO.	PART NO.	DESCRIPTION	REMARK
JR054	1-216-295-91	SHORT	0	Q364	8-729-216-22	TRANSISTOR 2SA1162-G	
JR1003	1-216-295-91	SHORT	0	Q365	8-729-422-27	TRANSISTOR 2SD601A-Q	
JR4120	1-216-295-91	SHORT	0	Q366	8-729-422-27	TRANSISTOR 2SD601A-Q	
	<b>COIL</b>			Q367	8-729-216-22	TRANSISTOR 2SA1162-G	
L001	1-410-482-31	INDUCTOR	100UH	Q368	8-729-216-22	TRANSISTOR 2SA1162-G	
L002	1-410-482-31	INDUCTOR	100UH	Q369	8-729-422-27	TRANSISTOR 2SD601A-Q	
L003	1-410-470-11	INDUCTOR	10UH	Q370	8-729-422-27	TRANSISTOR 2SD601A-Q	
L004	1-410-470-11	INDUCTOR	10UH	Q501	8-729-140-50	TRANSISTOR 2SC3209LK	
L351	1-410-476-11	INDUCTOR	33UH	Q502	8-729-045-26	TRANSISTOR 2SD2580-CA	
				Q503	8-729-422-27	TRANSISTOR 2SD601A-Q	
L352	1-410-482-31	INDUCTOR	100UH	Q504	8-729-422-27	TRANSISTOR 2SD601A-Q	
L502	1-412-552-11	INDUCTOR	2.2MMH	Q507	8-729-043-95	TRANSISTOR 2SC3840(3)	
L503	1-406-677-11	INDUCTOR	10MMH	Q511	8-729-422-27	TRANSISTOR 2SD601A-Q	
L504	1-406-677-11	INDUCTOR	10MMH	Q512	8-729-809-29	TRANSISTOR 2SC4159-E	
L505	1-406-976-11	INDUCTOR	68UH	Q561	8-729-422-27	TRANSISTOR 2SD601A-Q	
L511	1-411-189-11	INDUCTOR	15MMH	Q562	8-729-422-27	TRANSISTOR 2SD601A-Q	
L517	1-412-552-11	INDUCTOR	2.2MMH	Q1001	8-729-422-27	TRANSISTOR 2SD601A-Q	
L1101	1-410-482-31	INDUCTOR	100UH	Q1102	8-729-119-78	TRANSISTOR 2SC2785-HFE	
L1102	1-410-470-11	INDUCTOR	10UH	Q1103	8-729-422-27	TRANSISTOR 2SD601A-Q	
L1351	1-410-682-31	INDUCTOR	470UH	Q1351	8-729-422-27	TRANSISTOR 2SD601A-Q	
	<b>TRANSISTOR</b>			Q1352	8-729-422-27	TRANSISTOR 2SD601A-Q	
Q001	8-729-216-22	TRANSISTOR 2SA1162-G		Q1353	8-729-216-22	TRANSISTOR 2SA1162-G	
Q002	8-729-422-27	TRANSISTOR 2SD601A-Q		Q1354	8-729-422-27	TRANSISTOR 2SD601A-Q	
Q003	8-729-422-27	TRANSISTOR 2SD601A-Q			<b>RESISTOR</b>		
Q004	8-729-216-22	TRANSISTOR 2SA1162-G		R001	1-216-057-00	RES, CHIP	2.2K 5% 1/10W
Q005	8-729-422-27	TRANSISTOR 2SD601A-Q		R002	1-216-049-91	RES, CHIP	1K 5% 1/10W
Q010	8-729-422-27	TRANSISTOR 2SD601A-Q		R003	1-216-097-91	RES, CHIP	100K 5% 1/10W
Q011	8-729-422-27	TRANSISTOR 2SD601A-Q		R004	1-216-121-91	RES, CHIP	1M 5% 1/10W
Q012	8-729-422-27	TRANSISTOR 2SD601A-Q		R006	1-247-815-91	CARBON	220 5% 1/4W
Q013	8-729-422-27	TRANSISTOR 2SD601A-Q		R007	1-216-073-00	RES, CHIP	10K 5% 1/10W
Q014	8-729-422-27	TRANSISTOR 2SD601A-Q		R008	1-247-815-91	CARBON	220 5% 1/4W
Q015	8-729-422-27	TRANSISTOR 2SD601A-Q		R009	1-216-073-00	RES, CHIP	10K 5% 1/10W
Q016	8-729-422-27	TRANSISTOR 2SD601A-Q		R010	1-216-041-00	RES, CHIP	470 5% 1/10W
Q017	8-729-216-22	TRANSISTOR 2SA1162-G		R011	1-216-065-91	RES, CHIP	4.7K 5% 1/10W
Q304	8-729-216-22	TRANSISTOR 2SA1162-G		R012	1-216-033-00	RES, CHIP	220 5% 1/10W
Q305	8-729-216-22	TRANSISTOR 2SA1162-G		R013	1-216-065-91	RES, CHIP	4.7K 5% 1/10W
Q306	8-729-216-22	TRANSISTOR 2SA1162-G		R014	1-216-065-91	RES, CHIP	4.7K 5% 1/10W
Q351	8-729-422-27	TRANSISTOR 2SD601A-Q		R015	1-216-073-00	RES, CHIP	10K 5% 1/10W
Q354	8-729-422-27	TRANSISTOR 2SD601A-Q		R016	1-216-073-00	RES, CHIP	10K 5% 1/10W
Q356	8-729-216-22	TRANSISTOR 2SA1162-G		R019	1-249-425-11	CARBON	4.7K 5% 1/4W
Q357	8-729-422-27	TRANSISTOR 2SD601A-Q		R020	1-216-065-91	RES, CHIP	4.7K 5% 1/10W
Q358	8-729-422-27	TRANSISTOR 2SD601A-Q		R022	1-249-429-11	CARBON	10K 5% 1/4W
Q359	8-729-216-22	TRANSISTOR 2SA1162-G		R023	1-216-089-91	RES, CHIP	47K 5% 1/10W
Q360	8-729-422-27	TRANSISTOR 2SD601A-Q		R025	1-216-033-00	RES, CHIP	220 5% 1/10W
Q361	8-729-422-27	TRANSISTOR 2SD601A-Q		R026	1-216-121-91	RES, CHIP	1M 5% 1/10W
Q362	8-729-422-27	TRANSISTOR 2SD601A-Q		R028	1-249-429-11	CARBON	10K 5% 1/4W
Q363	8-729-216-22	TRANSISTOR 2SA1162-G					



REF.NO.	PART NO.	DESCRIPTION	REMARK			REF.NO.	PART NO.	DESCRIPTION	REMARK		
R029	1-216-025-91	RES, CHIP	100	5%	1/10W	R090	1-216-033-00	RES, CHIP	220	5%	1/10W
R030	1-249-425-11	CARBON	4.7K	5%	1/4W	R092	1-249-429-11	CARBON	10K	5%	1/4W
R031	1-247-815-91	CARBON	220	5%	1/4W	R093	1-216-065-91	RES, CHIP	4.7K	5%	1/10W
R032	1-247-815-91	CARBON	220	5%	1/4W	R097	1-216-065-91	RES, CHIP	4.7K	5%	1/10W
R036	1-216-049-91	RES, CHIP	1K	5%	1/10W	R099	1-216-065-91	RES, CHIP	4.7K	5%	1/10W
R037	1-216-049-91	RES, CHIP	1K	5%	1/10W	R131	1-216-037-00	RES, CHIP	330	5%	1/10W
R038	1-216-049-91	RES, CHIP	1K	5%	1/10W	R132	1-216-113-00	RES, CHIP	470K	5%	1/10W
R039	1-247-807-31	CARBON	100	5%	1/4W	R133	1-216-037-00	RES, CHIP	330	5%	1/10W
R040	1-247-815-91	CARBON	220	5%	1/4W	R135	1-216-073-00	RES, CHIP	10K	5%	1/10W
R041	1-216-065-91	RES, CHIP	4.7K	5%	1/10W	R136	1-216-073-00	RES, CHIP	10K	5%	1/10W
R042	1-216-065-91	RES, CHIP	4.7K	5%	1/10W	R137	1-216-049-91	RES, CHIP	1K	5%	1/10W
R043	1-216-033-00	RES, CHIP	220	5%	1/10W	R319	1-216-049-91	RES, CHIP	1K	5%	1/10W
R044	1-216-049-91	RES, CHIP	1K	5%	1/10W	R320	1-216-049-91	RES, CHIP	1K	5%	1/10W
R045	1-247-815-91	CARBON	220	5%	1/4W	R321	1-216-049-91	RES, CHIP	1K	5%	1/10W
R046	1-247-815-91	CARBON	220	5%	1/4W	R324	1-216-073-00	RES, CHIP	10K	5%	1/10W
R047	1-249-417-11	CARBON	1K	5%	1/4W	R328	1-216-295-91	SHORT	0		
R048	1-249-417-11	CARBON	1K	5%	1/4W	R333	1-216-295-91	SHORT	0		
R049	1-249-417-11	CARBON	1K	5%	1/4W	R336	1-249-387-11	CARBON	3.3	5%	1/4W F
R052	1-216-065-91	RES, CHIP	4.7K	5%	1/10W	R337	1-216-347-11	METAL OXIDE	0.68	5%	1W F
R053	1-216-065-91	RES, CHIP	4.7K	5%	1/10W	R346	1-208-806-11	RES, CHIP	10K	0.50%	1/10W
R054	1-216-065-91	RES, CHIP	4.7K	5%	1/10W	R347	1-216-025-91	RES, CHIP	100	5%	1/10W
R055	1-216-097-91	RES, CHIP	100K	5%	1/10W	R348	1-249-389-11	CARBON	4.7	5%	1/4W F
R056	1-216-033-00	RES, CHIP	220	5%	1/10W	R350	1-216-049-91	RES, CHIP	1K	5%	1/10W
R057	1-249-417-11	CARBON	1K	5%	1/4W	R352	1-208-803-11	RES, CHIP	7.5K	0.50%	1/10W
R058	1-216-041-00	RES, CHIP	470	5%	1/10W	R353	1-208-788-11	RES, CHIP	1.8K	0.50%	1/10W
R064	1-247-815-91	CARBON	220	5%	1/4W	R354	1-216-077-00	RES, CHIP	15K	5%	1/10W
R065	1-247-815-91	CARBON	220	5%	1/4W	R355	1-216-033-00	RES, CHIP	220	5%	1/10W
R066	1-247-815-91	CARBON	220	5%	1/4W	R356	1-216-033-00	RES, CHIP	220	5%	1/10W
R067	1-249-413-11	CARBON	470	5%	1/4W	R358	1-247-815-91	CARBON	220	5%	1/4W
R068	1-247-815-91	CARBON	220	5%	1/4W	R359	1-247-815-91	CARBON	220	5%	1/4W
R069	1-247-815-91	CARBON	220	5%	1/4W	R360	1-247-815-91	CARBON	220	5%	1/4W
R070	1-249-421-11	CARBON	2.2K	5%	1/4W	R361	1-216-025-91	RES, CHIP	100	5%	1/10W
R071	1-247-815-91	CARBON	220	5%	1/4W	R362	1-216-025-91	RES, CHIP	100	5%	1/10W
R072	1-216-033-00	RES, CHIP	220	5%	1/10W	R363	1-216-025-91	RES, CHIP	100	5%	1/10W
R073	1-216-033-00	RES, CHIP	220	5%	1/10W	R364	1-208-836-11	RES, CHIP	180K	0.50%	1/10W
R074	1-216-033-00	RES, CHIP	220	5%	1/10W	R365	1-216-097-91	RES, CHIP	100K	5%	1/10W
R075	1-216-033-00	RES, CHIP	220	5%	1/10W	R366	1-216-085-00	RES, CHIP	33K	5%	1/10W
R076	1-216-033-00	RES, CHIP	220	5%	1/10W	R367	1-216-097-91	RES, CHIP	100K	5%	1/10W
R077	1-216-033-00	RES, CHIP	220	5%	1/10W	R368	1-216-097-91	RES, CHIP	100K	5%	1/10W
R078	1-249-417-11	CARBON	1K	5%	1/4W	R369	1-216-097-91	RES, CHIP	100K	5%	1/10W
R079	1-216-033-00	RES, CHIP	220	5%	1/10W	R370	1-249-417-11	CARBON	1K	5%	1/4W
R080	1-216-065-91	RES, CHIP	4.7K	5%	1/10W	R371	1-216-053-00	RES, CHIP	1.5K	5%	1/10W
R081	1-216-025-91	RES, CHIP	100	5%	1/10W	R372	1-216-113-00	RES, CHIP	470K	5%	1/10W
R082	1-216-025-91	RES, CHIP	100	5%	1/10W	R373	1-216-073-00	RES, CHIP	10K	5%	1/10W
R083	1-249-429-11	CARBON	10K	5%	1/4W	R374	1-216-276-00	RES, CHIP	1.8M	5%	1/8W
R084	1-216-049-91	RES, CHIP	1K	5%	1/10W	R375	1-216-025-91	RES, CHIP	100	5%	1/10W
R087	1-247-815-91	CARBON	220	5%	1/4W	R376	1-216-073-00	RES, CHIP	10K	5%	1/10W



**Note:**

The components identified by **☒** in this manual have been carefully factory selected for each set in order to satisfy regulations regarding X-ray radiation. Should replacement be required, replace only with the value originally used.

**Note:**

The components identified with shading and a critical symbol **△** are critical for safety. Replace only with part number specified.

**Note:**

Les composants identifiés par un trame et une marque **△** sont critiques pour la sécurité. Ne les remplacer que par une pièce portant le numéro spécifié.

REF.NO.	PART NO.	DESCRIPTION	REMARK
R378	1-216-083-00	RES, CHIP	27K 5% 1/10W
R379	1-216-033-00	RES, CHIP	220 5% 1/10W
R380	1-247-815-91	CARBON	220 5% 1/4W
R381	1-247-815-91	CARBON	220 5% 1/4W
R382	1-216-037-00	RES, CHIP	330 5% 1/10W
R383	1-216-049-91	RES, CHIP	1K 5% 1/10W
R384	1-216-109-00	RES, CHIP	330K 5% 1/10W
R385	1-249-421-11	CARBON	2.2K 5% 1/4W
R386	1-216-049-91	RES, CHIP	1K 5% 1/10W
R387 △	1-216-049-91	RES, CHIP	1K 5% 1/10W
R388	1-216-089-91	RES, CHIP	47K 5% 1/10W
R389	1-216-067-00	RES, CHIP	5.6K 5% 1/10W
R390	1-216-041-00	RES, CHIP	470 5% 1/10W
R391	1-208-810-11	RES, CHIP	15K 0.50% 1/10W
R392	1-216-025-91	RES, CHIP	100 5% 1/10W
R393	1-216-041-00	RES, CHIP	470 5% 1/10W
R394	1-216-057-00	RES, CHIP	2.2K 5% 1/10W
R395	1-216-061-00	RES, CHIP	3.3K 5% 1/10W
R396	1-249-417-11	CARBON	1K 5% 1/4W
R397	1-247-843-11	CARBON	3.3K 5% 1/4W
R398	1-216-095-00	RES, CHIP	82K 5% 1/10W
R501	1-216-041-00	RES, CHIP	470 5% 1/10W
R502	1-216-065-91	RES, CHIP	4.7K 5% 1/10W
R503	1-249-425-11	CARBON	4.7K 5% 1/4W F
R504 △	1-216-455-21	METAL OXIDE	560 5% 2W F
R505	1-247-863-91	CARBON	22K 5% 1/4W
R506	1-215-861-00	METAL OXIDE	47 5% 1W F
R507	1-249-401-11	CARBON	47 5% 1/4W
R508	1-249-425-11	CARBON	4.7K 5% 1/4W
R509	1-260-324-11	CARBON	470 5% 1/2W
R510 △	1-215-860-11	METAL OXIDE	33 5% 1W F
R511 △	1-215-885-00	METAL OXIDE	68 5% 2W F (KV-32XBR200)
R511 △	1-215-886-00	METAL OXIDE	100 5% 2W F (KV-36XBR200)
R512 △	1-215-886-11	METAL OXIDE	100 5% 2W F
R514	1-216-081-00	RES, CHIP	22K 5% 1/10W
R515	1-208-812-11	RES, CHIP	18K 0.50% 1/10W
R516	1-208-790-11	RES, CHIP	2.2K 0.50% 1/10W
R517	1-249-417-11	CARBON	1K 5% 1/4W
R518	1-216-073-00	RES, CHIP	10K 5% 1/10W
R519	1-249-413-11	CARBON	470 5% 1/4W
R521	1-216-081-00	RES, CHIP	22K 5% 1/10W
R522	1-215-886-11	METAL OXIDE	100 5% 2W F
R523	1-208-806-11	RES, CHIP	10K 0.50% 1/10W
R524	1-249-429-11	CARBON	10K 5% 1/4W
R525	1-208-804-11	RES, CHIP	8.2K 0.50% 1/10W

REF.NO.	PART NO.	DESCRIPTION	REMARK
R527	1-216-097-91	RES, CHIP	100K 5% 1/10W
R528	1-208-814-11	RES, CHIP	22K 0.50% 1/10W
R529 △	1-208-814-11	RES, CHIP	22K 0.50% 1/10W
☒ R530 △	1-208-808-11	RES, CHIP	12K 0.50% 1/10W
☒ R531 △	1-208-824-11	RES, CHIP	56K 0.50% 1/10W
R532 △	1-208-760-11	RES, CHIP	120 0.50% 1/10W
R533 △	1-215-879-11	METAL OXIDE	47K 5% 1W F (KV-32XBR200)
R533 △	1-215-878-00	METAL OXIDE	33K 5% 1W F (KV-36XBR200)
R535	1-208-840-11	RES, CHIP	270K 0.50% 1/10W
R536 △	1-260-288-11	CARBON	0.47 5% 1/2W
R537 △	1-260-288-11	CARBON	0.47 5% 1/2W
R538	1-247-887-00	CARBON	220K 5% 1/4W
R539 △	1-215-891-11	METAL OXIDE	680 5% 2W F
R541	1-215-922-11	METAL OXIDE	6.8K 5% 3W F (KV-32XBR200)
R541	1-215-919-11	METAL OXIDE	2.2K 5% 3W F (KV-36XBR200)
R542	1-215-921-11	METAL OXIDE	4.7K 5% 3W F
R543 △	1-249-377-11	CARBON	0.47 5% 1/4W F
R544	1-216-113-00	RES, CHIP	470K 5% 1/10W
R545	1-249-387-11	CARBON	3.3 5% 1/4W F
R546	1-215-453-00	METAL	22K 1% 1/4W
R547	1-215-457-00	METAL	33K 1% 1/4W
R548	1-215-921-11	METAL OXIDE	4.7K 5% 3W F
R549	1-215-437-00	METAL	4.7K 1% 1/4W
R550 △	1-249-377-11	CARBON	0.47 5% 1/4W F
R551 △	1-215-873-00	METAL OXIDE	4.7K 5% 1W F
R552 △	1-216-455-21	METAL OXIDE	560 5% 2W F
R553 △	1-249-377-11	CARBON	0.47 5% 1/4W F
R554	1-215-894-11	METAL OXIDE	2.2K 5% 2W F
R555	1-249-441-11	CARBON	100K 5% 1/4W
R556	1-249-441-11	CARBON	100K 5% 1/4W
R557	1-249-441-11	CARBON	100K 5% 1/4W
R560	1-215-922-11	METAL OXIDE	6.8K 5% 3W F (KV-32XBR200)
R560	1-215-919-11	METAL OXIDE	2.2K 5% 3W F (KV-36XBR200)
R561	1-208-806-11	RES, CHIP	10K 0.50% 1/10W
R563	1-216-349-00	METAL OXIDE	1 5% 1W F
R564	1-215-373-31	METAL	10 1% 1/4W
R565	1-215-889-00	METAL OXIDE	330 5% 2W F
R566	1-208-802-11	RES, CHIP	6.8K 0.50% 1/10W
R567	1-249-385-11	CARBON	2.2 5% 1/4W F
R568	1-208-802-11	RES, CHIP	6.8K 0.50% 1/10W
R569	1-208-806-11	RES, CHIP	10K 0.50% 1/10W
R570	1-216-097-91	RES, CHIP	100K 5% 1/10W



<u>REF.NO.</u>	<u>PART NO.</u>	<u>DESCRIPTION</u>	<u>REMARK</u>			<u>REF.NO.</u>	<u>PART NO.</u>	<u>DESCRIPTION</u>	<u>REMARK</u>		
R571	1-216-081-00	RES, CHIP	22K	5%	1/10W	R1306	1-216-081-00	RES, CHIP	22K	5%	1/10W
R572	1-216-081-00	RES, CHIP	22K	5%	1/10W	R1307	1-216-049-91	RES, CHIP	1K	5%	1/10W
R573	1-216-097-91	RES, CHIP	100K	5%	1/10W	R1308	1-216-049-91	RES, CHIP	1K	5%	1/10W
R580	1-249-441-11	CARBON	100K	5%	1/4W	R1309	1-216-051-00	RES, CHIP	1.2K	5%	1/10W
R1001	1-247-807-31	CARBON	100	5%	1/4W	R1310	1-216-025-91	RES, CHIP	100	5%	1/10W
R1002	1-247-807-31	CARBON	100	5%	1/4W	R1311	1-216-025-91	RES, CHIP	100	5%	1/10W
R1003	1-216-073-00	RES, CHIP	10K	5%	1/10W	R1312	1-216-057-00	RES, CHIP	2.2K	5%	1/10W
R1004	1-216-067-00	RES, CHIP	5.6K	5%	1/10W	R1313	1-208-780-11	RES, CHIP	820	0.50%	1/10W
R1005	1-216-073-00	RES, CHIP	10K	5%	1/10W	R1314	1-208-782-11	RES, CHIP	1K	0.50%	1/10W
R1006	1-247-807-31	CARBON	100	5%	1/4W	R1315	1-216-025-91	RES, CHIP	100	5%	1/10W
R1007	1-247-807-31	CARBON	100	5%	1/4W	R1316	1-216-091-00	RES, CHIP	56K	5%	1/10W
R1008	1-216-065-91	RES, CHIP	4.7K	5%	1/10W	R1317	1-216-105-91	RES, CHIP	220K	5%	1/10W
R1009	1-216-073-00	RES, CHIP	10K	5%	1/10W	R1318	1-216-065-91	RES, CHIP	4.7K	5%	1/10W
R1010	1-216-049-91	RES, CHIP	1K	5%	1/10W	R1319	1-260-290-71	CARBON	0.68	5%	1/2W
R1011	1-249-387-11	CARBON	3.3	5%	1/4W F	R1322	1-216-073-00	RES, CHIP	10K	5%	1/10W
R1012	1-216-049-91	RES, CHIP	1K	5%	1/10W	R1323	1-216-065-91	RES, CHIP	4.7K	5%	1/10W
R1101	1-216-049-91	RES, CHIP	1K	5%	1/10W	R1326	1-249-417-11	CARBON	1K	5%	1/4W
R1102	1-215-900-11	METAL OXIDE	22K	5%	2W F	R1329	1-216-295-91	SHORT	0		
R1103	1-216-049-91	RES, CHIP	1K	5%	1/10W	R1330	1-216-065-91	RES, CHIP	4.7K	5%	1/10W
R1104	1-216-083-00	RES, CHIP	27K	5%	1/10W	R1333	1-216-065-91	RES, CHIP	4.7K	5%	1/10W
R1105	1-216-689-11	RES, CHIP	39K	5%	1/10W	R1337	1-216-049-91	RES, CHIP	1K	5%	1/10W
R1106	1-216-049-91	RES, CHIP	1K	5%	1/10W	R1351	1-247-815-91	CARBON	220	5%	1/4W
R1107	1-216-065-91	RES, CHIP	4.7K	5%	1/10W	R1352	1-247-815-91	CARBON	220	5%	1/4W
R1108	1-216-073-00	RES, CHIP	10K	5%	1/10W	R1353	1-247-815-91	CARBON	220	5%	1/4W
R1109	1-216-017-91	RES, CHIP	47	5%	1/10W	R1354	1-216-033-00	RES, CHIP	220	5%	1/10W
R1110	1-216-017-91	RES, CHIP	47	5%	1/10W	R1355	1-216-025-91	RES, CHIP	100	5%	1/10W
R1111	1-216-017-91	RES, CHIP	47	5%	1/10W	R1356	1-216-025-91	RES, CHIP	100	5%	1/10W
R1113	1-249-417-11	CARBON	1K	5%	1/4W	R1357	1-216-025-91	RES, CHIP	100	5%	1/10W
R1114	1-249-417-11	CARBON	1K	5%	1/4W	R1358	1-216-025-91	RES, CHIP	100	5%	1/10W
R1115	1-216-041-00	RES, CHIP	470	5%	1/10W	R1359	1-216-025-91	RES, CHIP	100	5%	1/10W
R1117	1-249-425-11	CARBON	4.7K	5%	1/4W	R1360	1-216-049-91	RES, CHIP	1K	5%	1/10W
R1118	1-249-425-11	CARBON	4.7K	5%	1/4W	R1361	1-216-049-91	RES, CHIP	1K	5%	1/10W
R1120	1-216-057-00	RES, CHIP	2.2K	5%	1/10W	R1362	1-216-113-00	RES, CHIP	470K	5%	1/10W
R1121	1-216-037-00	RES, CHIP	330	5%	1/10W	R1363	1-216-057-00	RES, CHIP	2.2K	5%	1/10W
R1122	1-216-113-00	RES, CHIP	470K	5%	1/10W	R1364	1-216-097-91	RES, CHIP	100K	5%	1/10W
R1123	1-216-037-00	RES, CHIP	330	5%	1/10W	R1365	1-216-089-91	RES, CHIP	47K	5%	1/10W
R1125	1-216-057-00	RES, CHIP	2.2K	5%	1/10W	R1366	1-216-107-00	RES, CHIP	270K	5%	1/10W
R1126	1-216-037-00	RES, CHIP	330	5%	1/10W	R1369	1-216-093-00	RES, CHIP	68K	5%	1/10W
R1127	1-216-113-00	RES, CHIP	470K	5%	1/10W	R1371	1-216-295-91	SHORT	0		
R1128	1-216-037-00	RES, CHIP	330	5%	1/10W	R1373	1-216-025-91	RES, CHIP	100	5%	1/10W
R1129	1-216-295-91	SHORT	0			R1374	1-216-089-91	RES, CHIP	47K	5%	1/10W
R1130	1-216-057-00	RES, CHIP	2.2K	5%	1/10W	R1385	1-216-049-91	RES, CHIP	1K	5%	1/10W
R1301	1-249-401-11	CARBON	47	5%	1/4W	R1386	1-216-049-91	RES, CHIP	1K	5%	1/10W
R1302	1-249-401-11	CARBON	47	5%	1/4W	R1387	1-249-429-11	CARBON	10K	5%	1/4W
R1303	1-216-049-91	RES, CHIP	1K	5%	1/10W	R1388	1-216-073-00	RES, CHIP	10K	5%	1/10W
R1304	1-216-049-91	RES, CHIP	1K	5%	1/10W	R1389	1-216-025-91	RES, CHIP	100	5%	1/10W
R1305	1-216-091-00	RES, CHIP	56K	5%	1/10W	R1390	1-249-417-11	CARBON	1K	5%	1/4W

**Note:**

The components identified with shading and a critical symbol  $\triangle$  are critical for safety. Replace only with part number specified.

**Note:**

Les composants identifiés par un trame et une marque  $\triangle$  sont critiques pour la sécurité. Ne les remplacer que par une pièce portant le numéro spécifié.

REF.NO.	PART NO.	DESCRIPTION	REMARK
R1391	1-216-091-00	RES,CHIP	56K 5% 1/10W
R1392	1-216-081-00	RES,CHIP	22K 5% 1/10W
R1393	1-216-049-91	RES,CHIP	1K 5% 1/10W
R1394	1-208-785-11	RES,CHIP	1.3K 0.50% 1/10W
R1395	1-208-782-11	RES,CHIP	1K 0.50% 1/10W
R1396	1-216-025-91	RES,CHIP	100 5% 1/10W
R1397	1-216-025-91	RES,CHIP	100 5% 1/10W
R1398	1-216-057-00	RES,CHIP	2.2K 5% 1/10W
R1399	1-216-049-91	RES,CHIP	1K 5% 1/10W

**SWITCH**

S501	1-572-707-11	SWITCH, LEVER
S502	1-572-707-11	SWITCH, LEVER

**TRANSFORMER**

T501	1-437-195-11	TRANSFORMER, HORIZONTAL DRIVE
T502 $\triangle$	1-426-981-11	TRANSFORMER, FERRITE (PMT)
T503 $\triangle$	1-453-282-11	TRANSFORMER, FLYBACK (KV-32XBR200)
T503 $\triangle$	1-453-286-11	TRANSFORMER, FLYBACK (KV-36XBR200)
T504	1-424-584-11	TRANSFORMER, DYNAMIC FOCUS
T505 $\triangle$	1-429-188-11	TRANSFORMER, HORIZONTAL LINEAR

**TUNER**

TU102 $\triangle$	8-598-431-00	TUNER, FSSBTF-WA411
-------------------	--------------	---------------------

**CRYSTAL**

X001	1-578-774-11	VIBRATOR, CRYSTAL
X353	1-567-505-11	OSCILLATOR, CRYSTAL
X354	1-579-583-11	VIBRATOR, CERAMIC



*	A-1298-641-A	AX BOARD, COMPLETE
---	--------------	--------------------

**CAPACITOR**

C101	1-126-960-11	ELECT	1MF	20%	50V
C102	1-164-161-11	CERAMIC CHIP	0.0022MF	10%	50V
C104	1-126-964-11	ELECT	10MF	20%	50V
C106	1-104-664-11	ELECT	47MF	20%	25V
C108	1-126-942-61	ELECT	1000MF	20%	25V
C109	1-163-259-91	CERAMIC CHIP	220PF	5%	50V
C110	1-163-809-11	CERAMIC CHIP	0.047MF	10%	25V
C111	1-126-960-11	ELECT	1MF	20%	50V
C113	1-104-666-11	ELECT	220MF	20%	25V

REF.NO.	PART NO.	DESCRIPTION	REMARK
C115	1-126-960-11	ELECT	1MF 20% 50V
C1904	1-102-129-00	CERAMIC	0.01MF 10% 50V
C1905	1-126-964-11	ELECT	10MF 20% 50V
C1906	1-102-129-00	CERAMIC	0.01MF 10% 50V
C1907	1-126-964-11	ELECT	10MF 20% 50V
C1908	1-163-009-11	CERAMIC CHIP	0.001MF 10% 50V
C1909	1-163-009-11	CERAMIC CHIP	0.001MF 10% 50V
C1910	1-163-009-11	CERAMIC CHIP	0.001MF 10% 50V
C1911	1-163-009-11	CERAMIC CHIP	0.001MF 10% 50V
C1912	1-163-009-11	CERAMIC CHIP	0.001MF 10% 50V

**CONNECTOR**

CN101	1-573-301-21	CONNECTOR, BOARD TO BOARD 20P
CN102	1-573-979-21	CONNECTOR, BOARD TO BOARD 11P
CN103*	1-564-507-11	PLUG, CONNECTOR 4P

**DIODE**

D101	8-719-109-89	DIODE RD5.6ESB2
D103	8-719-991-33	DIODE 1SS133T-77
D104	8-719-991-33	DIODE 1SS133T-77
D105	8-719-991-33	DIODE 1SS133T-77
D106	8-719-991-33	DIODE 1SS133T-77
D107	8-719-991-33	DIODE 1SS133T-77
D108	8-719-110-17	DIODE RD10ESB2
D109	8-719-110-17	DIODE RD10ESB2

**IC**

IC1901	8-752-058-68	IC CXA1315M
IC1902	8-759-470-63	IC NJM2145M-TE2

**CHIP CONDUCTOR**

JR101	1-216-295-91	SHORT	0
JR1901	1-216-295-91	SHORT	0

**COIL**

L102	1-410-470-11	INDUCTOR	10UH
L105	1-410-482-31	INDUCTOR	100UH

**TRANSISTOR**

Q101	8-729-119-78	TRANSISTOR 2SC2785-HFE
Q103	8-729-216-22	TRANSISTOR 2SA1162-G
Q104	8-729-216-22	TRANSISTOR 2SA1162-G
Q105	8-729-216-22	TRANSISTOR 2SA1162-G
Q106	8-729-422-27	TRANSISTOR 2SD601A-Q
Q1902	8-729-216-22	TRANSISTOR 2SA1162-G
Q1903	8-729-216-22	TRANSISTOR 2SA1162-G
Q1918	8-729-216-22	TRANSISTOR 2SA1162-G

## Note:

The components identified with shading and a critical symbol  $\triangle$  are critical for safety. Replace only with part number specified.

## Note:

Les composants identifiés par un trame et une marque  $\triangle$  sont critiques pour la sécurité. Ne les remplacer que par une pièce portant le numéro spécifié.

AX	BX
----	----

REF.NO.	PART NO.	DESCRIPTION	REMARK			REF.NO.	PART NO.	DESCRIPTION	REMARK		
<b>RESISTOR</b>						C3712	1-126-961-11	ELECT	2.2MF	20%	50V
R101	1-216-065-91	RES, CHIP	4.7K	5%	1/10W	C3713	1-163-038-91	CERAMIC CHIP	0.1MF		25V
R102	1-216-083-00	RES, CHIP	27K	5%	1/10W	C3722	1-126-959-11	ELECT	0.47MF	20%	50V
R103	1-216-689-11	RES, CHIP	39K	5%	1/10W	C3723	1-163-131-00	CERAMIC CHIP	390PF	5%	50V
R104	1-216-049-91	RES, CHIP	1K	5%	1/10W	C3724	1-163-021-91	CERAMIC CHIP	0.01MF	10%	50V
R106	1-216-081-00	RES, CHIP	22K	5%	1/10W	C3725	1-163-021-91	CERAMIC CHIP	0.01MF	10%	50V
R107	1-216-081-00	RES, CHIP	22K	5%	1/10W	C3727	1-163-038-91	CERAMIC CHIP	0.1MF		25V
R108	1-216-081-00	RES, CHIP	22K	5%	1/10W	C3728	1-163-037-11	CERAMIC CHIP	0.022MF	10%	50V
R109	1-216-081-00	RES, CHIP	22K	5%	1/10W	C3729	1-126-963-11	ELECT	4.7MF	20%	50V
R112	1-249-421-11	CARBON	2.2K	5%	1/4W	C3730	1-163-239-11	CERAMIC CHIP	33PF	5%	50V
R113	1-216-097-91	RES, CHIP	100K	5%	1/10W	C3731	1-163-227-11	CERAMIC CHIP	10PF	0.5PF	50V
R114	1-216-121-91	RES, CHIP	1M	5%	1/10W	C3732	1-163-235-11	CERAMIC CHIP	22PF	5%	50V
R115	1-216-073-00	RES, CHIP	10K	5%	1/10W	C3733	1-163-021-91	CERAMIC CHIP	0.01MF	10%	50V
R116	1-216-073-00	RES, CHIP	10K	5%	1/10W	C3734	1-126-964-11	ELECT	10MF	20%	50V
R117	1-216-065-91	RES, CHIP	4.7K	5%	1/10W	C3735	1-163-038-91	CERAMIC CHIP	0.1MF		25V
R1905	1-216-073-00	RES, CHIP	10K	5%	1/10W	C3736	1-163-038-91	CERAMIC CHIP	0.1MF		25V
R1906	1-216-073-00	RES, CHIP	10K	5%	1/10W	C3737	1-126-964-11	ELECT	10MF	20%	50V
R1920	1-216-073-00	RES, CHIP	10K	5%	1/10W	C3739	1-163-009-11	CERAMIC CHIP	0.001MF	10%	50V
R2904	1-216-033-00	RES, CHIP	220	5%	1/10W	C3741	1-163-009-11	CERAMIC CHIP	0.001MF	10%	50V
R2905	1-216-033-00	RES, CHIP	220	5%	1/10W	C3742	1-163-021-91	CERAMIC CHIP	0.01MF	10%	50V
R2909	1-216-073-00	RES, CHIP	10K	5%	1/10W	C3743	1-163-259-91	CERAMIC CHIP	220PF	5%	50V
R2910	1-216-073-00	RES, CHIP	10K	5%	1/10W	C3744	1-163-011-11	CERAMIC CHIP	0.0015MF	10%	50V
R2912	1-216-065-91	RES, CHIP	4.7K	5%	1/10W	C3745	1-126-963-11	ELECT	4.7MF	20%	50V
R2913	1-216-073-00	RES, CHIP	10K	5%	1/10W	C3746	1-163-021-91	CERAMIC CHIP	0.01MF	10%	50V
R2914	1-216-073-00	RES, CHIP	10K	5%	1/10W	C3747	1-163-021-91	CERAMIC CHIP	0.01MF	10%	50V
R2915	1-216-073-00	RES, CHIP	10K	5%	1/10W	C3755	1-163-038-91	CERAMIC CHIP	0.1MF		25V
R2916	1-216-073-00	RES, CHIP	10K	5%	1/10W	C3756	1-104-664-11	ELECT	47MF	20%	25V
<b>TUNER</b>						C3758	1-163-231-11	CERAMIC CHIP	15PF	5%	50V
TU101 $\triangle$	8-598-430-00	TUNER, FSSBTF-FA401				C3759	1-104-664-11	ELECT	47MF	20%	25V
<b>BX</b>						C3763	1-163-231-11	CERAMIC CHIP	15PF	5%	50V
* A-1135-902-A BX BOARD, COMPLETE						C3764	1-163-021-91	CERAMIC CHIP	0.01MF	10%	50V
<b>CAPACITOR</b>						C3766	1-163-038-91	CERAMIC CHIP	0.1MF		25V
C3701	1-104-664-11	ELECT	47MF	20%	25V	C3768	1-126-964-11	ELECT	10MF	20%	50V
C3703	1-163-231-11	CERAMIC CHIP	15PF	5%	50V	C3770	1-163-038-91	CERAMIC CHIP	0.1MF		25V
C3704	1-104-664-11	ELECT	47MF	20%	25V	C3771	1-163-038-91	CERAMIC CHIP	0.1MF		25V
C3706	1-104-664-11	ELECT	47MF	20%	25V	C3772	1-163-038-91	CERAMIC CHIP	0.1MF		25V
C3707	1-163-038-91	CERAMIC CHIP	0.1MF		25V	C3773	1-163-038-91	CERAMIC CHIP	0.1MF		25V
C3708	1-104-664-11	ELECT	47MF	20%	25V	C3774	1-126-964-11	ELECT	10MF	20%	50V
C3709	1-163-038-91	CERAMIC CHIP	0.1MF		25V	C3775	1-163-038-91	CERAMIC CHIP	0.1MF		25V
C3710	1-104-664-11	ELECT	47MF	20%	25V	C3776	1-126-964-11	ELECT	10MF	20%	50V
C3711	1-163-038-91	CERAMIC CHIP	0.1MF		25V	C3777	1-163-038-91	CERAMIC CHIP	0.1MF		25V
C3777	1-163-038-91	CERAMIC CHIP	0.1MF		25V	C3778	1-104-664-11	ELECT	47MF	20%	25V
C3778	1-104-664-11	ELECT	47MF	20%	25V	C3779	1-163-038-91	CERAMIC CHIP	0.1MF		25V
C3779	1-163-038-91	CERAMIC CHIP	0.1MF		25V	C3780	1-163-038-91	CERAMIC CHIP	0.1MF		25V
C3780	1-163-038-91	CERAMIC CHIP	0.1MF		25V	C3781	1-163-038-91	CERAMIC CHIP	0.1MF		25V
C3781	1-163-038-91	CERAMIC CHIP	0.1MF		25V	C3782	1-163-038-91	CERAMIC CHIP	0.1MF		25V
C3782	1-163-038-91	CERAMIC CHIP	0.1MF		25V	C3784	1-163-038-91	CERAMIC CHIP	0.1MF		25V
C3784	1-163-038-91	CERAMIC CHIP	0.1MF		25V						



REF.NO.	PART NO.	DESCRIPTION	REMARK	REF.NO.	PART NO.	DESCRIPTION	REMARK
C3785	1-163-021-91	CERAMIC CHIP	0.01MF 10% 50V	IC3708	8-759-429-95	ICMN47V76ST1	
C3786	1-126-964-11	ELECT	10MF 20% 50V	IC3709	8-759-422-80	ICMN47V77ST1	
C3787	1-163-038-91	CERAMIC CHIP	0.1MF 25V	<u>CHIP CONDUCTOR</u>			
C3788	1-163-038-91	CERAMIC CHIP	0.1MF 25V	JR3701	1-216-295-91	SHORT	0
C3789	1-163-038-91	CERAMIC CHIP	0.1MF 25V	JR3708	1-216-295-91	SHORT	0
C3790	1-163-038-91	CERAMIC CHIP	0.1MF 25V	JR3710	1-216-295-91	SHORT	0
C3791	1-163-038-91	CERAMIC CHIP	0.1MF 25V	JR3712	1-216-295-91	SHORT	0
C3792	1-164-004-11	CERAMIC CHIP	0.1MF 10% 25V	JR3714	1-216-295-91	SHORT	0
C3827	1-163-038-91	CERAMIC CHIP	0.1MF 25V	<u>COIL</u>			
C3828	1-163-021-91	CERAMIC CHIP	0.01MF 10% 50V	L3701	1-410-470-11	INDUCTOR	10UH
C3829	1-126-964-11	ELECT	10MF 20% 50V	L3702	1-410-470-11	INDUCTOR	10UH
C3830	1-163-038-91	CERAMIC CHIP	0.1MF 25V	L3706	1-410-470-11	INDUCTOR	10UH
C3831	1-126-964-11	ELECT	10MF 20% 50V	L3708	1-410-470-11	INDUCTOR	10UH
C3832	1-126-964-11	ELECT	10MF 20% 50V	L3709	1-410-466-41	INDUCTOR	4.7UH
C3833	1-126-964-11	ELECT	10MF 20% 50V	L3714	1-410-470-11	INDUCTOR	10UH
C3834	1-163-021-91	CERAMIC CHIP	0.01MF 10% 50V	<u>TRANSISTOR</u>			
C3835	1-126-960-11	ELECT	1MF 20% 50V	Q3701	8-729-216-22	TRANSISTOR 2SA1162-G	
C3836	1-128-551-11	ELECT	22MF 20% 25V	Q3702	8-729-216-22	TRANSISTOR 2SA1162-G	
<u>CONNECTOR</u>				Q3703	8-729-422-27	TRANSISTOR 2SD601A-Q	
CN3701	1-573-978-21	CONNECTOR, BOARD TO BOARD 11P		Q3707	8-729-422-27	TRANSISTOR 2SD601A-Q	
CN3702	1-573-297-21	CONNECTOR, BOARD TO BOARD 18P		Q3708	8-729-216-22	TRANSISTOR 2SA1162-G	
<u>DIODE</u>				Q3709	8-729-216-22	TRANSISTOR 2SA1162-G	
D3704	8-719-404-49	DIODE MA111		Q3719	8-729-422-27	TRANSISTOR 2SD601A-Q	
D3705	8-719-404-49	DIODE MA111		Q3724	8-729-422-27	TRANSISTOR 2SD601A-Q	
D3706	8-719-404-49	DIODE MA111		Q3725	8-729-216-22	TRANSISTOR 2SA1162-G	
D3707	8-719-404-49	DIODE MA111		Q3728	8-729-216-22	TRANSISTOR 2SA1162-G	
D3708	8-719-404-49	DIODE MA111		Q3729	8-729-216-22	TRANSISTOR 2SA1162-G	
<u>FERRITE BEAD</u>				Q3731	8-729-422-27	TRANSISTOR 2SD601A-Q	
FB3702	1-216-295-91	SHORT	0	Q3732	8-729-216-22	TRANSISTOR 2SA1162-G	
FB3703	1-216-295-91	SHORT	0	Q3733	8-729-422-27	TRANSISTOR 2SD601A-Q	
FB3706	1-216-295-91	SHORT	0	Q3734	8-729-422-27	TRANSISTOR 2SD601A-Q	
FB3707	1-216-295-91	SHORT	0	<u>RESISTOR</u>			
FB3708	1-216-295-91	SHORT	0	R3701	1-216-081-00	RES, CHIP	22K 5% 1/10W
<u>FILTER</u>				R3702	1-216-081-00	RES, CHIP	22K 5% 1/10W
FL3702	1-239-847-11	FILTER, LOW PASS		R3703	1-216-057-00	RES, CHIP	2.2K 5% 1/10W
FL3704	1-239-847-11	FILTER, LOW PASS		R3704	1-216-057-00	RES, CHIP	2.2K 5% 1/10W
FL3705	1-239-847-11	FILTER, LOW PASS		R3705	1-216-057-00	RES, CHIP	2.2K 5% 1/10W
FL3706	1-236-101-11	ENCAPSULATED COMPONENT		R3706	1-208-750-11	RES, CHIP	47 0.50% 1/10W
FL3707	1-236-101-11	ENCAPSULATED COMPONENT		R3707	1-208-762-11	RES, CHIP	150 0.50% 1/10W
<u>IC</u>				R3708	1-216-043-91	RES, CHIP	560 5% 1/10W
IC3702	8-759-701-56	IC NJM78M05FA		R3709	1-216-075-00	RES, CHIP	12K 5% 1/10W
IC3703	8-759-445-59	IC BA033T		R3710	1-216-081-00	RES, CHIP	22K 5% 1/10W
IC3705	8-759-296-53	IC UPC1862GS-E2		R3711	1-216-081-00	RES, CHIP	22K 5% 1/10W
IC3707	8-759-444-12	IC UPD6488GF-3BA		R3717	1-216-049-91	RES, CHIP	1K 5% 1/10W
				R3718	1-216-049-91	RES, CHIP	1K 5% 1/10W





## Note:

The components identified with shading and a critical symbol  $\triangle$  are critical for safety. Replace only with part number specified.

## Note:

Les composants identifiés par un trame et une marque  $\triangle$  sont critiques pour la sécurité. Ne les remplacer que par une pièce portant le numéro spécifié.

REF.NO.	PART NO.	DESCRIPTION	REMARK
C1775	1-102-129-00	CERAMIC	0.01MF 10% 50V
C1776	1-102-157-00	CERAMIC	560PF 10% 500V
C1777	1-107-957-11	ELECT	1MF 20% 250V
C1778	1-102-074-00	CERAMIC	0.001MF 10% 50V
C1779	1-137-490-11	FILM	0.01MF 10% 1KV
C1783	1-106-375-12	MYLAR	0.022MF 99% 200V
C1784	1-106-375-12	MYLAR	0.022MF 99% 200V
C1786	1-107-651-11	ELECT	4.7MF 20% 250V

**CONNECTOR**

CN1761*	1-564-509-11	PLUG, CONNECTOR 6P
CN1763	1-695-915-11	TAB (CONTACT)
CN1764*	1-564-508-11	PLUG, CONNECTOR 5P

**DIODE**

D1712	8-719-901-83	DIODE 1SS83
D1713	8-719-908-03	DIODE GP08D
D1762	8-719-991-33	DIODE 1SS133T-77
D1763	8-719-991-33	DIODE 1SS133T-77
D1764	8-719-991-33	DIODE 1SS133T-77
D1767	8-719-109-89	DIODE RD5.6ESB2
D1768	8-719-991-33	DIODE 1SS133T-77
D1769	8-719-109-71	DIODE RD3.9ESB1
D1770	8-719-901-83	DIODE 1SS83
D1771	8-719-901-83	DIODE 1SS83

**IC**

IC1761	8-759-346-42	ICTDA6101Q/N3
IC1762	8-759-346-42	ICTDA6101Q/N3
IC1763	8-759-346-42	ICTDA6101Q/N3

**JACK**

J1761 $\triangle$	1-540-071-22	SOCKET, CRT
-------------------	--------------	-------------

**COIL**

L1761	1-410-470-11	INDUCTOR	10UH
-------	--------------	----------	------

**TRANSISTOR**

Q1761	8-729-119-76	TRANSISTOR 2SA1175-HFE
-------	--------------	------------------------

**RESISTOR**

R1761	1-215-413-00	METAL	470	1%	1/4W
R1762	1-215-413-00	METAL	470	1%	1/4W
R1763	1-215-424-00	METAL	1.3K	1%	1/4W
R1764	1-249-441-11	CARBON	100K	5%	1/4W
R1765	1-247-863-91	CARBON	22K	5%	1/4W

REF.NO.	PART NO.	DESCRIPTION	REMARK
R1766	1-215-424-00	METAL	1.3K 1% 1/4W
R1767	1-249-437-11	CARBON	47K 5% 1/4W
R1768	1-247-807-31	CARBON	100 5% 1/4W
R1769	1-249-417-11	CARBON	1K 5% 1/4W
R1770	1-215-424-00	METAL	1.3K 1% 1/4W
R1771	1-249-432-11	CARBON	18K 5% 1/4W
R1772	1-249-421-11	CARBON	2.2K 5% 1/4W
R1773	1-249-422-11	CARBON	2.7K 5% 1/4W
R1774	1-215-903-11	METAL OXIDE	68K 5% 2W F
R1775	1-249-422-11	CARBON	2.7K 5% 1/4W
R1776	1-215-903-11	METAL OXIDE	68K 5% 2W F
R1777	1-260-099-11	CARBON	1K 5% 1/2W
R1778	1-249-422-11	CARBON	2.7K 5% 1/4W
R1779	1-215-903-11	METAL OXIDE	68K 5% 2W F
R1780	1-249-436-11	CARBON	39K 5% 1/4W
R1781	1-260-099-11	CARBON	1K 5% 1/2W
R1782	1-260-099-11	CARBON	1K 5% 1/2W
R1783	1-260-087-11	CARBON	100 5% 1/2W
R1786	1-260-115-11	CARBON	22K 5% 1/2W
R1787	1-216-374-00	METAL OXIDE	2.7 5% 2W F
R1788	1-260-132-11	CARBON	560K 5% 1/2W

**VARIABLE RESISTOR**

RV1761	1-241-714-11	RES, ADJ, METAL FILM 110M
--------	--------------	---------------------------



*	A-1316-397-A	G BOARD, COMPLETE
	1-533-223-11	HOLDER, FUSE
	4-382-854-11	SCREW (M3X10), P, SW (+)

**CAPACITOR**

C601	1-136-346-21	FILM	0.22MF	20%	125V
C602	1-126-964-11	ELECT	10MF	20%	50V
C603 $\triangle$	1-113-903-11	CERAMIC	0.001MF	20%	250V
C604 $\triangle$	1-136-346-21	FILM	0.22MF	20%	125V
C605 $\triangle$	1-136-346-21	FILM	0.22MF	20%	125V
C606 $\triangle$	1-117-894-11	ELECT	560MF	20%	250V
C607 $\triangle$	1-117-894-11	ELECT	560MF	20%	250V
C608	1-107-824-11	CERAMIC	220PF	5%	1KV
C609	1-136-176-00	FILM	0.82MF	5%	50V
C610	1-136-176-00	FILM	0.82MF	5%	50V
C611	1-136-169-00	FILM	0.22MF	5%	50V
C612	1-136-169-00	FILM	0.22MF	5%	50V
C613	1-164-646-11	CERAMIC	2200PF	10%	500V

**Note:**

The components identified with shading and a critical symbol  $\triangle$  are critical for safety. Replace only with part number specified.

**Note:**

Les composants identifiés par un trame et une marque  $\triangle$  sont critiques pour la sécurité. Ne les remplacer que par une pièce portant le numéro spécifié.

REF.NO.	PART NO.	DESCRIPTION	REMARK		
C614	1-126-963-11	ELECT	4.7MF	20%	50V
C615	1-117-976-11	FILM	0.039MF	5%	800V
C616 $\triangle$	1-113-903-11	CERAMIC	0.001MF	20%	250V
C618	1-126-968-11	ELECT	100MF	20%	50V
C624	1-126-960-11	ELECT	1MF	20%	50V
C629 $\triangle$	1-107-652-11	ELECT	10MF	20%	250V
C630	1-130-471-00	MYLAR	0.001MF	5%	50V
C631	1-137-605-11	FILM	0.01MF	10%	250V
C633	1-130-471-00	MYLAR	0.001MF	5%	50V
C634	1-130-467-00	MYLAR	470PF	5%	50V
C635	1-130-471-00	MYLAR	0.001MF	5%	50V
C636	1-126-965-11	ELECT	22MF	20%	50V
C637	1-126-940-11	ELECT	330MF	20%	25V
C641	1-128-550-11	ELECT	2200MF	20%	50V
C643	1-107-995-11	ELECT	100MF	0	160V
C644	1-104-664-11	ELECT	47MF	20%	25V
C647	1-104-665-11	ELECT	100MF	20%	25V
C650	1-104-664-11	ELECT	47MF	20%	25V
C651	1-130-477-00	MYLAR	0.0033MF	5%	50V
C652	1-106-351-00	MYLAR	0.0022MF	99%	200V
C653	1-107-636-11	ELECT	10MF	20%	160V
C656	1-126-964-11	ELECT	10MF	20%	50V
C657	1-137-372-11	FILM	0.022MF	5%	50V
C658	1-126-941-11	ELECT	470MF	20%	25V
C660	1-126-936-11	ELECT	3300MF	20%	16V
C661	1-104-664-11	ELECT	47MF	20%	25V
C662	1-126-933-11	ELECT	100MF	20%	16V
C665	1-104-664-11	ELECT	47MF	20%	25V
C695	1-164-625-11	CERAMIC	680PF	10%	500V
C696	1-164-625-11	CERAMIC	680PF	10%	500V
C697	1-164-625-11	CERAMIC	680PF	10%	500V
C698	1-164-625-11	CERAMIC	680PF	10%	500V
C699	1-136-169-00	FILM	0.22MF	5%	50V
<b>CONNECTOR</b>					
CN601*	1-573-963-11	PIN, CONNECTOR (PC BOARD) 3P			
CN602*	1-580-844-11	PIN, CONNECTOR (POWER)			
CN603*	1-573-963-11	PIN, CONNECTOR (PC BOARD) 3P			
CN641*	1-564-515-11	PLUG, CONNECTOR 12P			
CN642*	1-564-509-11	PLUG, CONNECTOR 6P			
CN643*	1-508-786-00	PIN, CONNECTOR (5MM PITCH) 2P			
<b>DIODE</b>					
D600	8-719-991-33	DIODE1SS133T-77			
D601	8-719-991-33	DIODE1SS133T-77			
D602 $\triangle$	8-719-510-53	DIODED4SB60L			
D603	8-719-063-70	DIODED1NL20U			

REF.NO.	PART NO.	DESCRIPTION	REMARK
D604	8-719-991-33	DIODE1SS133T-77	
D605	8-719-923-83	DIODEMTZJ-T-77-13A	
D606	8-719-110-63	DIODERD24ESB3	
D607	8-719-109-97	DIODERD6.8ESB2	
D608	8-719-109-97	DIODERD6.8ESB2	
D612	8-719-991-33	DIODE1SS133T-77	
D613	8-719-991-33	DIODE1SS133T-77	
D614	8-719-991-33	DIODE1SS133T-77	
D621	8-719-911-55	DIODE U05G	
D622	8-719-911-55	DIODE U05G	
D623	8-719-948-45	DIODEERA22-08	
D624	8-719-991-33	DIODE1SS133T-77	
D625	8-719-991-33	DIODE1SS133T-77	
D626	8-719-109-93	DIODERD6.2ESB2	
D627	8-719-510-48	DIODED1N20R	
D628	8-719-510-02	DIODED1NS4	
D629	8-719-052-90	DIODED1NL40-TA2	
D630	8-719-052-90	DIODED1NL40-TA2	
D641	8-719-060-89	DIODED4SBS6-F	
D642	8-719-510-12	DIODED10SC4M	
D643	8-719-062-40	DIODED4SBL20UF3	
D647	8-719-063-70	DIODED1NL20U	
D648	8-719-057-52	DIODEEZ0150AV1	
D651	8-719-510-02	DIODED1NS4	
D652	8-719-510-02	DIODED1NS4	
D653	8-719-991-33	DIODE1SS133T-77	
D698	8-719-991-33	DIODE1SS133T-77	
D699	8-719-923-86	DIODEMTZJ-T-77-15	
<b>FUSE</b>			
F601 $\triangle$	1-532-506-51	FUSE6.3A/250V	
<b>FERRITE BEAD</b>			
FB601	1-410-396-41	FERRITE	0.45UH
FB602	1-410-396-41	FERRITE	0.45UH
FB603	1-410-396-41	FERRITE	0.45UH
FB604	1-410-396-41	FERRITE	0.45UH
FB641	1-410-397-21	FERRITE	1.1UH
FB642	1-410-397-21	FERRITE	1.1UH
FB645	1-410-397-21	FERRITE	1.1UH
FB647	1-410-397-21	FERRITE	1.1UH
<b>IC</b>			
IC601 $\triangle$	8-729-045-41	TRANSISTORMX0842B-F	
IC622	8-759-450-47	ICBA05T	
IC641	8-759-198-03	ICPQ09RF21	
IC643 $\triangle$	8-749-012-13	POWER MODULE DM-58	





## Note:

The components identified with shading and a critical symbol  $\Delta$  are critical for safety. Replace only with part number specified.

## Note:

Les composants identifiés par un trame et une marque  $\Delta$  sont critiques pour la sécurité. Ne les remplacer que par une pièce portant le numéro spécifié.

REF.NO.	PART NO.	DESCRIPTION	REMARK	REF.NO.	PART NO.	DESCRIPTION	REMARK
IC650	8-759-394-35	ICBA12T		R624 $\Delta$	1-215-485-00	METAL	470K 1% 1/4W
IC651	8-759-450-47	ICBA05T		R625 $\Delta$	1-215-485-00	METAL	470K 1% 1/4W
<b>COIL</b>				R626	1-249-425-11	CARBON	4.7K 5% 1/4W
L642	1-412-529-11	INDUCTOR	22UH	R627	1-249-405-11	CARBON	100 5% 1/4W F
L650	1-412-519-11	INDUCTOR	3.3UH	R631	1-240-205-91	CARBON	22M 5% 1/2W
L651	1-412-519-11	INDUCTOR	3.3UH	R632	1-249-421-11	CARBON	2.2K 5% 1/4W
L652	1-412-519-11	INDUCTOR	3.3UH	R633	1-249-429-11	CARBON	10K 5% 1/4W
<b>TRANSISTOR</b>				R634	1-249-437-11	CARBON	47K 5% 1/4W
Q621 $\Delta$	8-729-044-30	TRANSISTOR2SK2845-LB102		R635	1-247-791-91	CARBON	22 5% 1/4W
Q622	8-729-119-78	TRANSISTOR2SC2785-HFE		R636	1-249-415-11	CARBON	680 5% 1/4W
Q623	8-729-119-78	TRANSISTOR2SC2785-HFE		R637	1-260-302-51	CARBON	6.8 5% 1/2W
Q624	8-729-026-41	TRANSISTOR2SA933AS-QRT		R638	1-249-413-11	CARBON	470 5% 1/4W
Q644	8-729-119-78	TRANSISTOR2SC2785-HFE		R639	1-249-389-11	CARBON	4.7 5% 1/4W F
Q645	8-729-119-76	TRANSISTOR2SA1175-HFE		R640	1-215-485-00	METAL	470K 1% 1/4W
Q646	8-729-119-76	TRANSISTOR2SA1175-HFE		R641	1-247-843-11	CARBON	3.3K 5% 1/4W
Q647	8-729-119-78	TRANSISTOR2SC2785-HFE		R642	1-247-843-11	CARBON	3.3K 5% 1/4W
Q648	8-729-922-39	TRANSISTOR2SD2144S-V		R643	1-249-387-11	CARBON	3.3 5% 1/4W F
Q649	8-729-119-76	TRANSISTOR2SA1175-HFE		R644	1-249-417-11	CARBON	1K 5% 1/4W
Q650	8-729-119-78	TRANSISTOR2SC2785-HFE		R645	1-249-429-11	CARBON	10K 5% 1/4W
Q651	8-729-802-71	TRANSISTOR2SA1407-E		R646	1-249-417-11	CARBON	1K 5% 1/4W
Q652	8-729-119-76	TRANSISTOR2SA1175-HFE		R648	1-249-441-11	CARBON	100K 5% 1/4W
Q653	8-729-119-78	TRANSISTOR2SC2785-HFE		R649	1-249-425-11	CARBON	4.7K 5% 1/4W F
<b>RESISTOR</b>				R650	1-249-421-11	CARBON	2.2K 5% 1/4W
R601	1-249-377-11	CARBON	0.47 5%	R651	1-215-908-00	METAL OXIDE	33 5% 3W F
R602	1-249-429-11	CARBON	10K 5%	R652 $\Delta$	1-216-363-00	METAL OXIDE	0.335% 2W F
R603 $\Delta$	1-219-776-11	CARBON	2.2M 10%	R653	1-215-423-00	METAL	1.2K 1% 1/4W
R604	1-249-429-11	CARBON	10K 5%	R654	1-215-481-00	METAL	330K 1% 1/4W
R605	1-249-429-11	CARBON	10K 5%	R655	1-215-469-00	METAL	100K 1% 1/4W
R606	1-249-421-11	CARBON	2.2K 5%	R656	1-249-427-11	CARBON	6.8K 5% 1/4W
R607 $\Delta$	1-202-933-61	FUSIBLE	0.1 10%	R657	1-249-421-11	CARBON	2.2K 5% 1/4W
R608	1-216-369-00	METAL OXIDE	1 5%	R659	1-249-429-11	CARBON	10K 5% 1/4W
R609	1-249-417-11	CARBON	1K 5%	R660	1-249-393-11	CARBON	10 5% 1/4W F
R610	1-249-425-11	CARBON	4.7K 5%	R661 $\Delta$	1-249-419-11	CARBON	1.5K 5% 1/4W F
R611	1-216-369-00	METAL OXIDE	1 5%	R662	1-215-485-00	METAL	470K 1% 1/4W
R612	1-260-124-11	CARBON	120K 5%	R663	1-215-445-00	METAL	10K 1% 1/4W
R613	1-260-124-11	CARBON	120K 5%	R664 $\Delta$	1-240-257-11	CMT, MELF	3.9 5% 20W
R614	1-260-124-11	CARBON	120K 5%	R665	1-249-425-11	CARBON	4.7K 5% 1/4W
R615	1-260-124-11	CARBON	120K 5%	R670	1-260-312-11	CARBON	47 5% 1/2W
R618	1-249-425-11	CARBON	4.7K 5%	R671	1-260-312-11	CARBON	47 5% 1/2W
R619	1-249-425-11	CARBON	4.7K 5%	R680	1-216-364-11	METAL OXIDE	0.39 5% 2W F
R621	1-249-429-11	CARBON	10K 5%	R681	1-216-365-00	METAL OXIDE	0.47 5% 2W F
R620	1-126-967-11	ELECT	47MF 20%	R699	1-249-429-11	CARBON	10K 5% 1/4W
R622	1-247-863-91	CARBON	22K 5%	<b>RELAY</b>			
R623 $\Delta$	1-240-257-11	CMT, MELF	3.9 5%	RY600 $\Delta$	1-755-266-11	RELAY, AC POWER	
				RY601 $\Delta$	1-755-146-11	RELAY, AC POWER	

**Note:**

The components identified with shading and a critical symbol  $\triangle$  are critical for safety. Replace only with part number specified.

**Note:**

Les composants identifiés par un triangle et une marque  $\triangle$  sont critiques pour la sécurité. Ne les remplacer que par une pièce portant le numéro spécifié.



REF.NO.	PART NO.	DESCRIPTION	REMARK
<u>TRANSFORMER</u>			
T601 $\triangle$	1-426-717-11	TRANSFORMER, LINE FILTER (LFT)	
T602 $\triangle$	1-426-717-11	TRANSFORMER, LINE FILTER (LFT)	
T603 $\triangle$	1-429-992-21	TRANSFORMER, CONVERTER (PRT)	
T605 $\triangle$	1-433-408-11	TRANSFORMER, CONVERTER	
T621 $\triangle$	1-431-852-11	TRANSFORMER, CONVERTER (SRT)	
<u>THERMISTOR</u>			
THP601 $\triangle$	1-809-539-11	THERMISTOR, POSITIVE	
THP602 $\triangle$	1-809-539-11	THERMISTOR, POSITIVE	
<u>VARISTOR</u>			
VDR602 $\triangle$	1-801-074-41	VARISTORERZV10D271	
<b>HF</b>			
*	A-1372-520-A	HF BOARD, MOUNTED	
<u>CAPACITOR</u>			
C1234	1-126-960-11	ELECT	1MF 20% 50V
C1235	1-126-960-11	ELECT	1MF 20% 50V
C2001	1-104-665-11	ELECT	100MF 20% 25V
<u>CONNECTOR</u>			
CN1232	1-564-524-11	PLUG, CONNECTOR 9P	
CN2001*	1-564-520-11	PLUG, CONNECTOR 5P	
<u>DIODE</u>			
D1233	8-719-110-17	DIODE RD10ESB2	
D2002	8-719-057-09	DIODE LNJ801LPDJA	
D2003	8-719-057-09	DIODE LNJ801LPDJA	
<u>IC</u>			
IC2001	8-742-014-11	HYBIC SBX1981-51	
<u>JACK</u>			
J1231	1-691-110-11	JACK, PIN 3P	
J1232	1-694-063-11	TERMINAL, S	
<u>RESISTOR</u>			
R1233	1-216-065-91	RES, CHIP	4.7K 5% 1/10W
R1235	1-216-065-91	RES, CHIP	4.7K 5% 1/10W
R1236	1-216-113-00	RES, CHIP	470K 5% 1/10W
R1237	1-216-065-91	RES, CHIP	4.7K 5% 1/10W
R1238	1-216-113-00	RES, CHIP	470K 5% 1/10W

REF.NO.	PART NO.	DESCRIPTION	REMARK
R2001	1-216-041-00	RES, CHIP	470 5% 1/10W
R2002	1-216-041-00	RES, CHIP	470 5% 1/10W
R2003	1-249-401-11	CARBON	47 5% 1/4W

**HX**

\* A-1372-526-A HX BOARD (VAR), MOUNTED

CONNECTOR

CN2002\* 1-564-518-11 PLUG, CONNECTOR 3P

RESISTOR

R2010	1-216-047-91	RES, CHIP	820 5% 1/10W
R2011	1-216-049-91	RES, CHIP	1K 5% 1/10W
R2012	1-216-055-00	RES, CHIP	1.8K 5% 1/10W
R2013	1-216-065-91	RES, CHIP	4.7K 5% 1/10W
R2014	1-216-073-00	RES, CHIP	10K 5% 1/10W
R2015	1-216-025-91	RES, CHIP	100 5% 1/10W

SWITCH

S2001	1-572-198-11	SWITCH, KEYBOARD
S2002	1-572-198-11	SWITCH, KEYBOARD
S2003	1-572-198-11	SWITCH, KEYBOARD
S2004	1-572-198-11	SWITCH, KEYBOARD
S2005	1-572-198-11	SWITCH, KEYBOARD
S2006	1-572-198-11	SWITCH, KEYBOARD
S2007	1-572-198-11	SWITCH, KEYBOARD

**K**

\* A-1385-185-A K BOARD, COMPLETE

4-382-854-11 SCREW (M3X10), P, SW (+)

CAPACITOR

C1461	1-126-960-11	ELECT	1MF 20% 50V
C1462	1-126-960-11	ELECT	1MF 20% 50V
C1464	1-163-038-91	CERAMIC CHIP	0.1MF 25V
C1465	1-126-960-11	ELECT	1MF 20% 50V
C1467	1-126-941-11	ELECT	470MF 20% 25V
C1468	1-126-960-11	ELECT	1MF 20% 50V
C1470	1-126-960-11	ELECT	1MF 20% 50V
C1471	1-136-165-00	FILM	0.1MF 5% 50V
C1472	1-137-194-81	FILM	0.47MF 5% 50V
C1473	1-128-550-11	ELECT	2200MF 20% 50V



REF.NO.	PART NO.	DESCRIPTION	REMARK			REF.NO.	PART NO.	DESCRIPTION	REMARK		
C1474	1-136-165-00	FILM	0.1MF	5%	50V	C5227	1-107-725-11	CERAMIC CHIP	0.1MF	10%	16V
C1475	1-128-550-11	ELECT	2200MF	20%	50V	C5228	1-107-725-11	CERAMIC CHIP	0.1MF	10%	16V
C1476	1-128-550-11	ELECT	2200MF	20%	50V	C5229	1-107-725-11	CERAMIC CHIP	0.1MF	10%	16V
C1477	1-126-971-11	ELECT	470MF	20%	50V	C5230	1-126-967-11	ELECT	47MF	20%	50V
C1478	1-126-971-11	ELECT	470MF	20%	50V	C5231	1-107-725-11	CERAMIC CHIP	0.1MF	10%	16V
C2401	1-126-963-11	ELECT	4.7MF	20%	50V	C5232	1-107-725-11	CERAMIC CHIP	0.1MF	10%	16V
C2402	1-126-964-11	ELECT	10MF	20%	50V	C5233	1-126-960-11	ELECT	1MF	20%	50V
C2403	1-126-963-11	ELECT	4.7MF	20%	50V	C5234	1-107-725-11	CERAMIC CHIP	0.1MF	10%	16V
C2404	1-163-038-91	CERAMIC CHIP	0.1MF		25V	C5235	1-107-725-11	CERAMIC CHIP	0.1MF	10%	16V
C2405	1-163-038-91	CERAMIC CHIP	0.1MF		25V						
C2406	1-163-038-91	CERAMIC CHIP	0.1MF		25V						
C2407	1-163-038-91	CERAMIC CHIP	0.1MF		25V						
C2408	1-164-182-11	CERAMIC CHIP	0.0033MF	10%	50V						
C2409	1-163-009-11	CERAMIC CHIP	0.001MF	10%	50V						
C2410	1-164-182-11	CERAMIC CHIP	0.0033MF	10%	50V						
C2411	1-163-009-11	CERAMIC CHIP	0.001MF	10%	50V						
C2414	1-164-222-11	CERAMIC CHIP	0.22MF		25V						
C2415	1-126-965-11	ELECT	22MF	20%	50V						
C2416	1-104-665-11	ELECT	100MF	20%	25V						
C2418	1-104-666-11	ELECT	220MF	20%	25V						
C2420	1-164-005-11	CERAMIC CHIP	0.47MF		25V						
C2421	1-126-964-11	ELECT	10MF	20%	50V						
C2422	1-126-964-11	ELECT	10MF	20%	50V						
C5201	1-107-725-11	CERAMIC CHIP	0.1MF	10%	16V						
C5202	1-126-967-11	ELECT	47MF	20%	50V						
C5203	1-126-963-11	ELECT	4.7MF	20%	50V						
C5204	1-107-725-11	CERAMIC CHIP	0.1MF	10%	16V						
C5205	1-126-967-11	ELECT	47MF	20%	50V						
C5206	1-126-967-11	ELECT	47MF	20%	50V						
C5207	1-126-967-11	ELECT	47MF	20%	50V						
C5208	1-126-967-11	ELECT	47MF	20%	50V						
C5209	1-107-725-11	CERAMIC CHIP	0.1MF	10%	16V						
C5210	1-126-963-11	ELECT	4.7MF	20%	50V						
C5211	1-164-690-91	CERAMIC CHIP	0.0022MF	5%	50V						
C5212	1-164-690-91	CERAMIC CHIP	0.0022MF	5%	50V						
C5213	1-163-227-11	CERAMIC CHIP	10PF	0.5PF	50V						
C5214	1-163-275-11	CERAMIC CHIP	0.001MF	5%	50V						
C5215	1-163-243-11	CERAMIC CHIP	47PF	5%	50V						
C5216	1-107-725-11	CERAMIC CHIP	0.1MF	10%	16V						
C5217	1-126-967-11	ELECT	47MF	20%	50V						
C5218	1-126-967-11	ELECT	47MF	20%	50V						
C5219	1-107-725-11	CERAMIC CHIP	0.1MF	10%	16V						
C5220	1-107-725-11	CERAMIC CHIP	0.1MF	10%	16V						
C5221	1-126-967-11	ELECT	47MF	20%	50V						
C5222	1-126-967-11	ELECT	47MF	20%	50V						
C5223	1-164-690-91	CERAMIC CHIP	0.0022MF	5%	50V						
C5224	1-164-690-91	CERAMIC CHIP	0.0022MF	5%	50V						
<b>CONNECTOR</b>											
	CN1462*	1-564-507-11	PLUG, CONNECTOR 4P								
	CN1463*	1-564-509-11	PLUG, CONNECTOR 6P								
	CN5001*	1-564-508-11	PLUG, CONNECTOR 5P								
	CN5002*	1-564-507-11	PLUG, CONNECTOR 4P								
	CN5003*	1-564-507-11	PLUG, CONNECTOR 4P								
<b>DIODE</b>											
	D1461	8-719-404-49	DIODE MA111								
	D1463	8-719-404-49	DIODE MA111								
<b>FERRITE BEAD</b>											
	FB5201	1-410-397-21	FERRITE						1.1UH		
<b>FILTER</b>											
	FL5201	1-239-803-11	ENCAPSULATED COMPONENT								
<b>IC</b>											
	IC1461	8-759-168-24	ICTA8200AH								
	IC2401	8-759-369-39	ICBH3856FS-E2								
	IC5201	8-759-549-74	ICTC9447F-003								
	IC5202	8-759-998-74	ICRH5VA33CC								
<b>CHIP CONDUCTOR</b>											
	JR1410	1-216-295-91	SHORT							0	
	JR1411	1-216-295-91	SHORT							0	
	JR1413	1-216-295-91	SHORT							0	
	JR1419	1-216-295-91	SHORT							0	
	JR1424	1-216-295-91	SHORT							0	
	JR1425	1-216-295-91	SHORT							0	
	JR1426	1-216-295-91	SHORT							0	
	JR1427	1-216-295-91	SHORT							0	
	JR1461	1-216-295-91	SHORT							0	
	JR1462	1-216-295-91	SHORT							0	
	JR5211	1-216-295-91	SHORT							0	
	JR5214	1-216-295-91	SHORT							0	
	JR5217	1-216-295-91	SHORT							0	



REF.NO.	PART NO.	DESCRIPTION	REMARK	REF.NO.	PART NO.	DESCRIPTION	REMARK
JR5225	1-216-295-91	SHORT	0	R5213	1-216-065-91	RES, CHIP	4.7K 5% 1/10W
JR5226	1-216-295-91	SHORT	0	R5214	1-216-069-00	RES, CHIP	6.8K 5% 1/10W
<b>COIL</b>				<b>CRYSTAL</b>			
L5201	1-408-595-31	INDUCTOR	2.2UH	X5201	1-579-834-11	VIBRATOR, CRYSTAL	
L5203	1-408-607-31	INDUCTOR	22UH	<b>PX</b>			
L5204	1-408-607-31	INDUCTOR	22UH	* A-1195-141-A BOARD, COMPLETE			
<b>IC LINK</b>				4-382-854-11 SCREW (M3X10), P, SW (+)			
PS1461	1-532-984-11	LINK, IC2A/90V		<b>CAPACITOR</b>			
<b>TRANSISTOR</b>				C3301	1-104-664-11	ELECT	47MF 20% 25V
Q1461	8-729-422-27	TRANSISTOR 2SD601A-Q		C3302	1-163-809-11	CERAMIC CHIP	0.047MF 10% 25V
Q1462	8-729-422-27	TRANSISTOR 2SD601A-Q		C3303	1-163-809-11	CERAMIC CHIP	0.047MF 10% 25V
Q1463	8-729-900-53	TRANSISTOR DTC114EK		C3304	1-163-809-11	CERAMIC CHIP	0.047MF 10% 25V
Q1464	8-729-900-53	TRANSISTOR DTC114EK		C3306	1-163-021-91	CERAMIC CHIP	0.01MF 10% 50V
<b>RESISTOR</b>				C3307	1-126-960-11	ELECT	1MF 20% 50V
R1461	1-216-033-00	RES, CHIP	220 5% 1/10W	C3308	1-126-935-11	ELECT	470MF 20% 16V
R1462	1-216-073-00	RES, CHIP	10K 5% 1/10W	C3310	1-163-017-00	CERAMIC CHIP	0.0047MF 10% 50V
R1464	1-216-033-00	RES, CHIP	220 5% 1/10W	C3311	1-126-963-11	ELECT	4.7MF 20% 50V
R1465	1-216-089-91	RES, CHIP	47K 5% 1/10W	C3312	1-164-004-11	CERAMIC CHIP	0.1MF 10% 25V
R1466	1-216-089-91	RES, CHIP	47K 5% 1/10W	C3314	1-164-346-11	CERAMIC CHIP	1MF 16V
R1467	1-216-073-00	RES, CHIP	10K 5% 1/10W	C3315	1-163-251-11	CERAMIC CHIP	100PF 5% 50V
R1469	1-249-389-11	CARBON	4.7 5% 1/4W F	C3316	1-163-133-00	CERAMIC CHIP	470PF 5% 50V
R1470	1-249-389-11	CARBON	4.7 5% 1/4W F	C3317	1-126-959-11	ELECT	0.47MF 20% 50V
R1471	1-216-049-91	RES, CHIP	1K 5% 1/10W	C3318	1-163-231-11	CERAMIC CHIP	15PF 5% 50V
R1472	1-216-077-00	RES, CHIP	15K 5% 1/10W	C3319	1-163-038-91	CERAMIC CHIP	0.1MF 25V
R1473	1-216-049-91	RES, CHIP	1K 5% 1/10W	C3320	1-163-038-91	CERAMIC CHIP	0.1MF 25V
R1474	1-216-295-91	SHORT	0	C3321	1-107-701-11	ELECT	47MF 20% 16V
R1475	1-216-295-91	SHORT	0	C3322	1-164-004-11	CERAMIC CHIP	0.1MF 10% 25V
R1480	1-216-057-00	RES, CHIP	2.2K 5% 1/10W	C3323	1-163-038-91	CERAMIC CHIP	0.1MF 25V
R1481	1-216-057-00	RES, CHIP	2.2K 5% 1/10W	C3324	1-163-038-91	CERAMIC CHIP	0.1MF 25V
R1482	1-216-295-91	SHORT	0	C3325	1-163-038-91	CERAMIC CHIP	0.1MF 25V
R1483	1-216-295-91	SHORT	0	C3326	1-163-038-91	CERAMIC CHIP	0.1MF 25V
R2424	1-216-025-91	RES, CHIP	100 5% 1/10W	C3327	1-163-133-00	CERAMIC CHIP	470PF 5% 50V
R2425	1-216-025-91	RES, CHIP	100 5% 1/10W	C3329	1-163-038-91	CERAMIC CHIP	0.1MF 25V
R5201	1-216-065-91	RES, CHIP	4.7K 5% 1/10W	C3330	1-164-004-11	CERAMIC CHIP	0.1MF 10% 25V
R5202	1-216-065-91	RES, CHIP	4.7K 5% 1/10W	C3331	1-164-004-11	CERAMIC CHIP	0.1MF 10% 25V
R5203	1-216-065-91	RES, CHIP	4.7K 5% 1/10W	C3332	1-163-038-91	CERAMIC CHIP	0.1MF 25V
R5204	1-216-049-91	RES, CHIP	1K 5% 1/10W	C3333	1-163-038-91	CERAMIC CHIP	0.1MF 25V
R5205	1-216-049-91	RES, CHIP	1K 5% 1/10W	C3334	1-164-004-11	CERAMIC CHIP	0.1MF 10% 25V
R5206	1-216-129-00	RES, CHIP	2.2M 5% 1/10W	C3335	1-163-038-91	CERAMIC CHIP	0.1MF 25V
R5207	1-216-035-00	RES, CHIP	270 5% 1/10W	C3336	1-163-038-91	CERAMIC CHIP	0.1MF 25V
R5208	1-216-035-00	RES, CHIP	270 5% 1/10W	C3339	1-164-346-11	CERAMIC CHIP	1MF 16V
R5210	1-216-033-00	RES, CHIP	220 5% 1/10W				
R5211	1-216-033-00	RES, CHIP	220 5% 1/10W				
R5212	1-216-065-91	RES, CHIP	4.7K 5% 1/10W				



REF.NO.	PART NO.	DESCRIPTION	REMARK	REF.NO.	PART NO.	DESCRIPTION	REMARK
C3340	1-163-133-00	CERAMIC CHIP	470PF 5% 50V	C3451	1-163-038-91	CERAMIC CHIP	0.1MF 25V
C3342	1-163-038-91	CERAMIC CHIP	0.1MF 25V	C3452	1-164-346-11	CERAMIC CHIP	1MF 16V
C3343	1-164-004-11	CERAMIC CHIP	0.1MF 10% 25V	C3453	1-163-017-00	CERAMIC CHIP	0.0047MF 10% 50V
C3344	1-164-004-11	CERAMIC CHIP	0.1MF 10% 25V	C3454	1-163-037-11	CERAMIC CHIP	0.022MF 10% 50V
C3345	1-164-004-11	CERAMIC CHIP	0.1MF 10% 25V	C3455	1-164-346-11	CERAMIC CHIP	1MF 16V
C3346	1-164-004-11	CERAMIC CHIP	0.1MF 10% 25V	C3456	1-163-038-91	CERAMIC CHIP	0.1MF 25V
C3347	1-164-004-11	CERAMIC CHIP	0.1MF 10% 25V	C3457	1-163-038-91	CERAMIC CHIP	0.1MF 25V
C3348	1-163-038-91	CERAMIC CHIP	0.1MF 25V	C3458	1-104-664-11	ELECT	47MF 20% 25V
C3349	1-163-038-91	CERAMIC CHIP	0.1MF 25V	C3459	1-163-231-11	CERAMIC CHIP	15PF 5% 50V
C3351	1-163-038-91	CERAMIC CHIP	0.1MF 25V	C3460	1-163-038-91	CERAMIC CHIP	0.1MF 25V
C3352	1-163-038-91	CERAMIC CHIP	0.1MF 25V	C3461	1-163-017-00	CERAMIC CHIP	0.0047MF 10% 50V
C3353	1-163-038-91	CERAMIC CHIP	0.1MF 25V	C3462	1-163-038-91	CERAMIC CHIP	0.1MF 25V
C3354	1-163-038-91	CERAMIC CHIP	0.1MF 25V	C3463	1-163-038-91	CERAMIC CHIP	0.1MF 25V
C3355	1-163-038-91	CERAMIC CHIP	0.1MF 25V	C3464	1-163-038-91	CERAMIC CHIP	0.1MF 25V
C3356	1-164-004-11	CERAMIC CHIP	0.1MF 10% 25V	C3465	1-163-038-91	CERAMIC CHIP	0.1MF 25V
C3357	1-163-038-91	CERAMIC CHIP	0.1MF 25V	C3466	1-164-005-11	CERAMIC CHIP	0.47MF 25V
C3358	1-163-038-91	CERAMIC CHIP	0.1MF 25V	C3467	1-163-038-91	CERAMIC CHIP	0.1MF 25V
C3359	1-163-038-91	CERAMIC CHIP	0.1MF 25V	C3468	1-163-021-91	CERAMIC CHIP	0.01MF 10% 50V
C3360	1-163-251-11	CERAMIC CHIP	100PF 5% 50V	C3469	1-104-664-11	ELECT	47MF 20% 25V
C3364	1-164-004-11	CERAMIC CHIP	0.1MF 10% 25V	C3470	1-163-038-91	CERAMIC CHIP	0.1MF 25V
C3365	1-104-664-11	ELECT	47MF 20% 25V	<b>FILTER BLOCK</b>			
C3366	1-164-004-11	CERAMIC CHIP	0.1MF 10% 25V	CM3301	1-473-983-11	FILTER BLOCK, COMB	
C3367	1-104-664-11	ELECT	47MF 20% 25V	<b>CONNECTOR</b>			
C3386	1-104-664-11	ELECT	47MF 20% 25V	CN3301	1-764-812-11	CONNECTOR, BOARD TO BOARD 11P	
C3387	1-163-809-11	CERAMIC CHIP	0.047MF 10% 25V	CN3302*	1-764-815-11	CONNECTOR, BOARD TO BOARD 18P	
C3388	1-163-809-11	CERAMIC CHIP	0.047MF 10% 25V	<b>DIODE</b>			
C3389	1-163-809-11	CERAMIC CHIP	0.047MF 10% 25V	D3302	8-719-404-49	DIODE MA111	
C3391	1-163-021-91	CERAMIC CHIP	0.01MF 10% 50V	D3303	8-719-404-49	DIODE MA111	
C3392	1-126-960-11	ELECT	1MF 20% 50V	D3313	8-719-404-49	DIODE MA111	
C3393	1-163-133-00	CERAMIC CHIP	470PF 5% 50V	D3314	8-719-404-49	DIODE MA111	
C3394	1-126-959-11	ELECT	0.47MF 20% 50V	D3451	8-719-053-40	DIODESCO16-2-TE12RA	
C3395	1-163-231-11	CERAMIC CHIP	15PF 5% 50V	<b>FERRITE BEAD</b>			
C3396	1-126-963-11	ELECT	4.7MF 20% 50V	FB3301	1-414-233-21	INDUCTOR CHIP	OUH
C3397	1-126-935-11	ELECT	470MF 20% 16V	FB3302	1-414-233-21	INDUCTOR CHIP	OUH
C3399	1-163-017-00	CERAMIC CHIP	0.0047MF 10% 50V	FB3303	1-414-233-21	INDUCTOR CHIP	OUH
C3400	1-164-346-11	CERAMIC CHIP	1MF 16V	FB3304	1-414-233-21	INDUCTOR CHIP	OUH
C3401	1-163-251-11	CERAMIC CHIP	100PF 5% 50V	FB3305	1-414-233-21	INDUCTOR CHIP	OUH
C3402	1-164-004-11	CERAMIC CHIP	0.1MF 10% 25V	FB3306	1-414-233-21	INDUCTOR CHIP	OUH
C3406	1-104-664-11	ELECT	47MF 20% 25V	FB3307	1-414-233-21	INDUCTOR CHIP	OUH
C3407	1-104-664-11	ELECT	47MF 20% 25V	FB3308	1-414-233-21	INDUCTOR CHIP	OUH
C3408	1-104-664-11	ELECT	47MF 20% 25V	<b>IC</b>			
C3409	1-164-004-11	CERAMIC CHIP	0.1MF 10% 25V	IC3301	8-759-932-69	ICBU4053BCF-T2	
C3412	1-126-959-11	ELECT	0.47MF 20% 50V	IC3302	8-752-086-80	ICXA2019AQ-T4	
C3413	1-163-021-91	CERAMIC CHIP	0.01MF 10% 50V				
C3416	1-126-959-11	ELECT	0.47MF 20% 50V				
C3417	1-104-664-11	ELECT	47MF 20% 25V				
C3418	1-163-021-91	CERAMIC CHIP	0.01MF 10% 50V				



REF.NO.	PART NO.	DESCRIPTION	REMARK	REF.NO.	PART NO.	DESCRIPTION	REMARK
IC3303	8-759-351-59	ICTC528257J-80(EL)		R3306	1-216-295-91	SHORT	0
IC3304	8-759-498-32	IC SAB9076H/N4		R3307	1-216-033-00	RES, CHIP	220 5% 1/10W
IC3306	8-759-231-53	ICTA7805S		R3311	1-216-025-91	RES, CHIP	100 5% 1/10W
IC3308	8-759-932-69	ICBU4053BCF-T2		R3312	1-216-025-91	RES, CHIP	100 5% 1/10W
IC3309	8-752-086-80	ICXA2019AQ-T4		R3313	1-216-025-91	RES, CHIP	100 5% 1/10W
IC3310	8-759-366-24	ICTDA8315T/N3A-T		R3314	1-216-073-00	RES, CHIP	10K 5% 1/10W
IC3311	8-759-432-78	ICMM1111XFBE		R3315	1-216-071-00	RES, CHIP	8.2K 5% 1/10W
	<u>COIL</u>			R3316	1-216-077-00	RES, CHIP	15K 5% 1/10W
L3301	1-408-607-31	INDUCTOR	22UH	R3317	1-216-053-00	RES, CHIP	1.5K 5% 1/10W
L3304	1-410-462-11	INDUCTOR	2.2UH	R3318	1-216-033-00	RES, CHIP	220 5% 1/10W
L3305	1-410-462-11	INDUCTOR	2.2UH	R3320	1-216-057-00	RES, CHIP	2.2K 5% 1/10W
	<u>TRANSISTOR</u>			R3322	1-216-061-00	RES, CHIP	3.3K 5% 1/10W
Q3301	8-729-216-22	TRANSISTOR 2SA1162-G		R3323	1-216-065-91	RES, CHIP	4.7K 5% 1/10W
Q3302	8-729-216-22	TRANSISTOR 2SA1162-G		R3324	1-216-065-91	RES, CHIP	4.7K 5% 1/10W
Q3303	8-729-216-22	TRANSISTOR 2SA1162-G		R3325	1-216-073-00	RES, CHIP	10K 5% 1/10W
Q3305	8-729-216-22	TRANSISTOR 2SA1162-G		R3326	1-216-049-91	RES, CHIP	1K 5% 1/10W
Q3306	8-729-216-22	TRANSISTOR 2SA1162-G		R3327	1-216-025-91	RES, CHIP	100 5% 1/10W
Q3307	8-729-216-22	TRANSISTOR 2SA1162-G		R3328	1-216-025-91	RES, CHIP	100 5% 1/10W
Q3308	8-729-422-27	TRANSISTOR 2SD601A-Q		R3329	1-216-025-91	RES, CHIP	100 5% 1/10W
Q3309	8-729-422-27	TRANSISTOR 2SD601A-Q		R3330	1-216-025-91	RES, CHIP	100 5% 1/10W
Q3310	8-729-422-27	TRANSISTOR 2SD601A-Q		R3331	1-216-001-00	RES, CHIP	10 5% 1/10W
Q3311	8-729-422-27	TRANSISTOR 2SD601A-Q		R3332	1-216-001-00	RES, CHIP	10 5% 1/10W
Q3318	8-729-216-22	TRANSISTOR 2SA1162-G		R3333	1-216-025-91	RES, CHIP	100 5% 1/10W
Q3319	8-729-216-22	TRANSISTOR 2SA1162-G		R3334	1-216-009-00	RES, CHIP	22 5% 1/10W
Q3320	8-729-216-22	TRANSISTOR 2SA1162-G		R3335	1-216-009-00	RES, CHIP	22 5% 1/10W
Q3325	8-729-216-22	TRANSISTOR 2SA1162-G		R3336	1-216-009-00	RES, CHIP	22 5% 1/10W
Q3326	8-729-216-22	TRANSISTOR 2SA1162-G		R3339	1-216-025-91	RES, CHIP	100 5% 1/10W
Q3327	8-729-216-22	TRANSISTOR 2SA1162-G		R3340	1-216-025-91	RES, CHIP	100 5% 1/10W
Q3330	8-729-216-22	TRANSISTOR 2SA1162-G		R3341	1-216-025-91	RES, CHIP	100 5% 1/10W
Q3333	8-729-216-22	TRANSISTOR 2SA1162-G		R3342	1-216-009-00	RES, CHIP	22 5% 1/10W
Q3339	8-729-422-27	TRANSISTOR 2SD601A-Q		R3343	1-216-009-00	RES, CHIP	22 5% 1/10W
Q3342	8-729-422-27	TRANSISTOR 2SD601A-Q		R3344	1-216-009-00	RES, CHIP	22 5% 1/10W
Q3343	8-729-216-22	TRANSISTOR 2SA1162-G		R3345	1-216-025-91	RES, CHIP	100 5% 1/10W
Q3344	8-729-422-27	TRANSISTOR 2SD601A-Q		R3347	1-216-001-00	RES, CHIP	10 5% 1/10W
Q3345	8-729-422-27	TRANSISTOR 2SD601A-Q		R3348	1-216-001-00	RES, CHIP	10 5% 1/10W
Q3346	8-729-422-27	TRANSISTOR 2SD601A-Q		R3350	1-216-025-91	RES, CHIP	100 5% 1/10W
Q3347	8-729-422-27	TRANSISTOR 2SD601A-Q		R3351	1-216-025-91	RES, CHIP	100 5% 1/10W
Q3451	8-729-422-27	TRANSISTOR 2SD601A-Q		R3352	1-216-025-91	RES, CHIP	100 5% 1/10W
	<u>RESISTOR</u>			R3353	1-216-001-00	RES, CHIP	10 5% 1/10W
R3301	1-216-049-91	RES, CHIP	1K 5% 1/10W	R3354	1-216-033-00	RES, CHIP	220 5% 1/10W
R3302	1-216-049-91	RES, CHIP	1K 5% 1/10W	R3355	1-216-033-00	RES, CHIP	220 5% 1/10W
R3303	1-216-049-91	RES, CHIP	1K 5% 1/10W	R3356	1-216-025-91	RES, CHIP	100 5% 1/10W
R3304	1-216-295-91	SHORT	0	R3357	1-216-033-00	RES, CHIP	220 5% 1/10W
R3305	1-216-295-91	SHORT	0	R3358	1-216-001-00	RES, CHIP	10 5% 1/10W
				R3359	1-216-057-00	RES, CHIP	2.2K 5% 1/10W
				R3361	1-216-049-91	RES, CHIP	1K 5% 1/10W
				R3362	1-216-295-91	SHORT	0



REF.NO.	PART NO.	DESCRIPTION	REMARK
R3363	1-216-065-91	RES, CHIP	4.7K 5% 1/10W
R3364	1-216-065-91	RES, CHIP	4.7K 5% 1/10W
R3365	1-216-049-91	RES, CHIP	1K 5% 1/10W
R3366	1-216-065-91	RES, CHIP	4.7K 5% 1/10W
R3367	1-216-073-00	RES, CHIP	10K 5% 1/10W
R3368	1-216-073-00	RES, CHIP	10K 5% 1/10W
R3369	1-216-065-91	RES, CHIP	4.7K 5% 1/10W
R3370	1-216-025-91	RES, CHIP	100 5% 1/10W
R3372	1-216-025-91	RES, CHIP	100 5% 1/10W
R3375	1-216-049-91	RES, CHIP	1K 5% 1/10W
R3379	1-216-308-00	RES, CHIP	4.7 5% 1/10W
R3380	1-216-049-91	RES, CHIP	1K 5% 1/10W
R3381	1-216-308-00	RES, CHIP	4.7 5% 1/10W
R3383	1-216-049-91	RES, CHIP	1K 5% 1/10W
R3384	1-216-049-91	RES, CHIP	1K 5% 1/10W
R3385	1-216-295-91	SHORT	0
R3386	1-216-295-91	SHORT	0
R3387	1-216-295-91	SHORT	0
R3408	1-216-049-91	RES, CHIP	1K 5% 1/10W
R3409	1-216-049-91	RES, CHIP	1K 5% 1/10W
R3410	1-216-049-91	RES, CHIP	1K 5% 1/10W
R3413	1-216-295-91	SHORT	0
R3414	1-216-295-91	SHORT	0
R3415	1-216-295-91	SHORT	0
R3419	1-216-033-00	RES, CHIP	220 5% 1/10W
R3420	1-216-025-91	RES, CHIP	100 5% 1/10W
R3421	1-216-025-91	RES, CHIP	100 5% 1/10W
R3422	1-216-025-91	RES, CHIP	100 5% 1/10W
R3423	1-216-071-00	RES, CHIP	8.2K 5% 1/10W
R3425	1-216-077-00	RES, CHIP	15K 5% 1/10W
R3426	1-216-053-00	RES, CHIP	1.5K 5% 1/10W
R3427	1-216-033-00	RES, CHIP	220 5% 1/10W
R3430	1-216-057-00	RES, CHIP	2.2K 5% 1/10W
R3431	1-216-061-00	RES, CHIP	3.3K 5% 1/10W
R3434	1-216-295-91	SHORT	0
R3435	1-216-295-91	SHORT	0
R3438	1-216-025-91	RES, CHIP	100 5% 1/10W
R3450	1-216-065-91	RES, CHIP	4.7K 5% 1/10W
R3451	1-216-073-00	RES, CHIP	10K 5% 1/10W
R3452	1-216-049-91	RES, CHIP	1K 5% 1/10W
R3453	1-216-025-91	RES, CHIP	100 5% 1/10W
R3454	1-216-025-91	RES, CHIP	100 5% 1/10W
R3456	1-216-049-91	RES, CHIP	1K 5% 1/10W
R3457	1-216-049-91	RES, CHIP	1K 5% 1/10W
R3460	1-216-073-00	RES, CHIP	10K 5% 1/10W
R3463	1-216-057-00	RES, CHIP	2.2K 5% 1/10W
R3466	1-216-295-91	SHORT	0

REF.NO.	PART NO.	DESCRIPTION	REMARK
R3468	1-216-295-91	SHORT	0
R3470	1-216-037-00	RES, CHIP	330 5% 1/10W
R3471	1-216-109-00	RES, CHIP	330K 5% 1/10W
R3472	1-216-025-91	RES, CHIP	100 5% 1/10W
R3473	1-216-295-91	SHORT	0
R3475	1-216-037-00	RES, CHIP	330 5% 1/10W
R3476	1-216-025-91	RES, CHIP	100 5% 1/10W
R3477	1-216-109-00	RES, CHIP	330K 5% 1/10W
R3479	1-216-295-91	SHORT	0
R3480	1-216-295-91	SHORT	0
R3481	1-216-295-91	SHORT	0
R3484	1-216-295-91	SHORT	0
R3485	1-216-295-91	SHORT	0
R3487	1-216-295-91	SHORT	0
R3488	1-216-295-91	SHORT	0
R3491	1-216-075-00	RES, CHIP	12K 5% 1/10W
R3492	1-216-025-91	RES, CHIP	100 5% 1/10W
R3493	1-216-041-00	RES, CHIP	470 5% 1/10W
R3494	1-216-045-00	RES, CHIP	680 5% 1/10W
R3495	1-216-097-91	RES, CHIP	100K 5% 1/10W
R3496	1-216-073-00	RES, CHIP	10K 5% 1/10W
R3497	1-216-295-91	SHORT	0

**CRYSTAL**

X3301	1-579-583-11	VIBRATOR, CERAMIC	
X3302	1-567-505-11	OSCILLATOR, CRYSTAL	
X3303	1-579-583-11	VIBRATOR, CERAMIC	
X3304	1-567-505-11	OSCILLATOR, CRYSTAL	
X3451	1-567-505-11	OSCILLATOR, CRYSTAL	



\* A-1394-907-A UX BOARD, COMPLETE

**CAPACITOR**

C151	1-126-960-11	ELECT	1MF	20%	50V
C152	1-126-960-11	ELECT	1MF	20%	50V
C167	1-104-665-11	ELECT	100MF	20%	25V
C201	1-128-551-11	ELECT	22MF	20%	25V
C202	1-128-551-11	ELECT	22MF	20%	25V
C203	1-128-551-11	ELECT	22MF	20%	25V
C204	1-126-960-11	ELECT	1MF	20%	50V
C205	1-126-960-11	ELECT	1MF	20%	50V
C231	1-163-021-91	CERAMIC CHIP	0.01MF	10%	50V
C232	1-128-551-11	ELECT	22MF	20%	25V
C233	1-128-551-11	ELECT	22MF	20%	25V
C234	1-126-960-11	ELECT	1MF	20%	50V



REF.NO.	PART NO.	DESCRIPTION	REMARK	REF.NO.	PART NO.	DESCRIPTION	REMARK
C235	1-126-960-11	ELECT	1MF 20% 50V	D246	8-719-157-94	DIODE RD3.3SB	
C236	1-128-551-11	ELECT	22MF 20% 25V	D247	8-719-157-94	DIODE RD3.3SB	
C237	1-126-960-11	ELECT	1MF 20% 50V	D248	8-719-157-94	DIODE RD3.3SB	
C238	1-126-960-11	ELECT	1MF 20% 50V	D249	8-719-157-94	DIODE RD3.3SB	
C241	1-126-941-11	ELECT	470MF 20% 25V	D250	8-719-157-94	DIODE RD3.3SB	
C242	1-126-959-11	ELECT	0.47MF 20% 50V	D261	8-719-032-47	DIODE MTZJ-T-9110	
C243	1-126-959-11	ELECT	0.47MF 20% 50V	D902	8-719-032-47	DIODE MTZJ-T-9110	
C244	1-126-959-11	ELECT	0.47MF 20% 50V	D910	8-719-032-47	DIODE MTZJ-T-9110	
C245	1-126-959-11	ELECT	0.47MF 20% 50V	D911	8-719-032-47	DIODE MTZJ-T-9110	
C247	1-126-941-11	ELECT	470MF 20% 25V	D912	8-719-032-47	DIODE MTZJ-T-9110	
C248	1-126-959-11	ELECT	0.47MF 20% 50V	D1051	8-719-404-49	DIODE MA111	
C249	1-126-959-11	ELECT	0.47MF 20% 50V	D1052	8-719-404-49	DIODE MA111	
C272	1-163-231-11	CERAMIC CHIP	15PF 5% 50V	D2201	8-719-032-47	DIODE MTZJ-T-9110	
C273	1-128-551-11	ELECT	22MF 20% 25V	D2202	8-719-032-47	DIODE MTZJ-T-9110	
C277	1-128-551-11	ELECT	22MF 20% 25V	D2203	8-719-032-47	DIODE MTZJ-T-9110	
C278	1-128-551-11	ELECT	22MF 20% 25V			<u>IC</u>	
C279	1-163-021-91	CERAMIC CHIP	0.01MF 10% 50V	IC261	8-752-066-69	ICCX1845Q	
C281	1-128-551-11	ELECT	22MF 20% 25V	IC1051	8-752-058-68	ICCX1315M	
C283	1-126-941-11	ELECT	470MF 20% 25V	IC1402	8-759-100-96	ICUPC4558G2	
C284	1-126-941-11	ELECT	470MF 20% 25V			<u>JACK</u>	
C1051	1-126-964-11	ELECT	10MF 20% 50V	J231	1-750-515-11	TERMINAL BLOCK, S 3P	
C1053	1-104-665-11	ELECT	100MF 20% 25V	J232	1-750-517-11	JACK BLOCK, PIN 3P	
C2201	1-126-965-11	ELECT	22MF 20% 50V	J233	1-750-516-11	JACK BLOCK, PIN 2P	
C2202	1-126-965-11	ELECT	22MF 20% 50V	J234	1-750-517-11	JACK BLOCK, PIN 3P	
C2203	1-163-021-91	CERAMIC CHIP	0.01MF 10% 50V	J235	1-750-517-11	JACK BLOCK, PIN 3P	
		<u>CONNECTOR</u>		J236	1-774-358-11	JACK BLOCK, PIN	
CN261	1-573-300-21	CONNECTOR, BOARD TO BOARD 18P		J902	1-764-143-11	JACK 3P	
CN262	1-573-301-21	CONNECTOR, BOARD TO BOARD 20P		J903	1-764-143-11	JACK 3P	
CN264*	1-691-632-21	CONNECTOR, BOARD TO BOARD 15P		J904	1-764-143-11	JACK 3P	
CN1401*	1-564-508-11	PLUG, CONNECTOR 5P		J905	1-764-143-11	JACK 3P	
CN1402*	1-564-507-11	PLUG, CONNECTOR 4P				<u>CHIP CONDUCTOR</u>	
		<u>DIODE</u>		JR1470	1-216-295-91	SHORT	0
D201	8-719-032-47	DIODE MTZJ-T-9110		JR1471	1-216-295-91	SHORT	0
D202	8-719-032-47	DIODE MTZJ-T-9110				<u>COIL</u>	
D203	8-719-032-47	DIODE MTZJ-T-9110		L261	1-410-482-31	INDUCTOR	100UH
D204	8-719-032-47	DIODE MTZJ-T-9110				<u>TRANSISTOR</u>	
D205	8-719-032-47	DIODE MTZJ-T-9110		Q202	8-729-422-27	TRANSISTOR 2SD601A-Q	
D231	8-719-032-47	DIODE MTZJ-T-9110		Q203	8-729-422-27	TRANSISTOR 2SD601A-Q	
D232	8-719-032-47	DIODE MTZJ-T-9110		Q205	8-729-216-22	TRANSISTOR 2SA1162-G	
D233	8-719-032-47	DIODE MTZJ-T-9110		Q206	8-729-216-22	TRANSISTOR 2SA1162-G	
D234	8-719-032-47	DIODE MTZJ-T-9110		Q208	8-729-422-27	TRANSISTOR 2SD601A-Q	
D235	8-719-032-47	DIODE MTZJ-T-9110		Q209	8-729-422-27	TRANSISTOR 2SD601A-Q	
D236	8-719-032-47	DIODE MTZJ-T-9110		Q210	8-729-422-27	TRANSISTOR 2SD601A-Q	
D237	8-719-032-47	DIODE MTZJ-T-9110					
D238	8-719-032-47	DIODE MTZJ-T-9110					
D239	8-719-032-47	DIODE MTZJ-T-9110					
D245	8-719-157-94	DIODE RD3.3SB					





REF.NO.	PART NO.	DESCRIPTION	REMARK	REF.NO.	PART NO.	DESCRIPTION	REMARK
Q211	8-729-216-22	TRANSISTOR2SA1162-G		R229	1-216-049-91	RES, CHIP	1K 5% 1/10W
Q212	8-729-422-27	TRANSISTOR2SD601A-Q		R230	1-216-089-91	RES, CHIP	47K 5% 1/10W
Q231	8-729-422-27	TRANSISTOR2SD601A-Q		R231	1-216-022-00	RES, CHIP	75 5% 1/10W
Q233	8-729-422-27	TRANSISTOR2SD601A-Q		R232	1-216-022-00	RES, CHIP	75 5% 1/10W
Q234	8-729-422-27	TRANSISTOR2SD601A-Q		R233	1-216-065-91	RES, CHIP	4.7K 5% 1/10W
Q235	8-729-422-27	TRANSISTOR2SD601A-Q		R234	1-216-022-00	RES, CHIP	75 5% 1/10W
Q236	8-729-422-27	TRANSISTOR2SD601A-Q		R235	1-216-113-00	RES, CHIP	470K 5% 1/10W
Q237	8-729-216-22	TRANSISTOR2SA1162-G		R236	1-216-113-00	RES, CHIP	470K 5% 1/10W
Q238	8-729-216-22	TRANSISTOR2SA1162-G		R237	1-216-022-00	RES, CHIP	75 5% 1/10W
Q239	8-729-216-22	TRANSISTOR2SA1162-G		R238	1-216-113-00	RES, CHIP	470K 5% 1/10W
Q240	8-729-422-27	TRANSISTOR2SD601A-Q		R239	1-216-113-00	RES, CHIP	470K 5% 1/10W
Q241	8-729-422-27	TRANSISTOR2SD601A-Q		R240	1-216-097-91	RES, CHIP	100K 5% 1/10W
Q242	8-729-422-27	TRANSISTOR2SD601A-Q		R241	1-216-113-00	RES, CHIP	470K 5% 1/10W
Q243	8-729-216-22	TRANSISTOR2SA1162-G		R242	1-216-049-91	RES, CHIP	1K 5% 1/10W
Q244	8-729-216-22	TRANSISTOR2SA1162-G		R243	1-216-113-00	RES, CHIP	470K 5% 1/10W
Q245	8-729-216-22	TRANSISTOR2SA1162-G		R244	1-216-049-91	RES, CHIP	1K 5% 1/10W
Q246	8-729-422-27	TRANSISTOR2SD601A-Q		R245	1-216-022-00	RES, CHIP	75 5% 1/10W
Q262	8-729-216-22	TRANSISTOR2SA1162-G		R246	1-216-113-00	RES, CHIP	470K 5% 1/10W
Q263	8-729-216-22	TRANSISTOR2SA1162-G		R247	1-216-113-00	RES, CHIP	470K 5% 1/10W
Q264	8-729-216-22	TRANSISTOR2SA1162-G		R248	1-216-113-00	RES, CHIP	470K 5% 1/10W
Q265	8-729-422-27	TRANSISTOR2SD601A-Q		R249	1-216-065-91	RES, CHIP	4.7K 5% 1/10W
Q266	8-729-216-22	TRANSISTOR2SA1162-G		R250	1-216-065-91	RES, CHIP	4.7K 5% 1/10W
Q267	8-729-216-22	TRANSISTOR2SA1162-G		R251	1-216-065-91	RES, CHIP	4.7K 5% 1/10W
Q268	8-729-216-22	TRANSISTOR2SA1162-G		R252	1-216-049-91	RES, CHIP	1K 5% 1/10W
Q1051	8-729-216-22	TRANSISTOR2SA1162-G		R254	1-216-049-91	RES, CHIP	1K 5% 1/10W
		<b>RESISTOR</b>		R256	1-216-295-91	SHORT	0
R201	1-216-022-00	RES, CHIP	75 5% 1/10W	R257	1-216-049-91	RES, CHIP	1K 5% 1/10W
R202	1-216-022-00	RES, CHIP	75 5% 1/10W	R258	1-216-065-91	RES, CHIP	4.7K 5% 1/10W
R203	1-216-022-00	RES, CHIP	75 5% 1/10W	R259	1-216-049-91	RES, CHIP	1K 5% 1/10W
R204	1-216-113-00	RES, CHIP	470K 5% 1/10W	R260	1-216-065-91	RES, CHIP	4.7K 5% 1/10W
R205	1-216-113-00	RES, CHIP	470K 5% 1/10W	R261	1-216-025-91	RES, CHIP	100 5% 1/10W
R206	1-216-295-91	SHORT	0	R262	1-216-067-00	RES, CHIP	5.6K 5% 1/10W
R207	1-216-295-91	SHORT	0	R263	1-216-025-91	RES, CHIP	100 5% 1/10W
R208	1-216-295-91	SHORT	0	R264	1-216-067-00	RES, CHIP	5.6K 5% 1/10W
R211	1-216-089-91	RES, CHIP	47K 5% 1/10W	R265	1-216-025-91	RES, CHIP	100 5% 1/10W
R212	1-216-081-00	RES, CHIP	22K 5% 1/10W	R266	1-216-025-91	RES, CHIP	100 5% 1/10W
R213	1-216-089-91	RES, CHIP	47K 5% 1/10W	R267	1-216-025-91	RES, CHIP	100 5% 1/10W
R214	1-216-081-00	RES, CHIP	22K 5% 1/10W	R268	1-216-067-00	RES, CHIP	5.6K 5% 1/10W
R218	1-208-774-11	RES, CHIP	470 0.50% 1/10W	R269	1-216-067-00	RES, CHIP	5.6K 5% 1/10W
R219	1-216-049-91	RES, CHIP	1K 5% 1/10W	R270	1-216-049-91	RES, CHIP	1K 5% 1/10W
R220	1-208-776-11	RES, CHIP	560 0.50% 1/10W	R271	1-216-067-00	RES, CHIP	5.6K 5% 1/10W
R221	1-208-774-11	RES, CHIP	470 0.50% 1/10W	R272	1-216-025-91	RES, CHIP	100 5% 1/10W
R222	1-216-049-91	RES, CHIP	1K 5% 1/10W	R273	1-216-067-00	RES, CHIP	5.6K 5% 1/10W
R223	1-208-776-11	RES, CHIP	560 0.50% 1/10W	R274	1-216-049-91	RES, CHIP	1K 5% 1/10W
R225	1-216-025-91	RES, CHIP	100 5% 1/10W	R275	1-216-025-91	RES, CHIP	100 5% 1/10W
R226	1-216-025-91	RES, CHIP	100 5% 1/10W	R276	1-216-295-91	SHORT	0
R228	1-216-049-91	RES, CHIP	1K 5% 1/10W	R278	1-216-067-00	RES, CHIP	5.6K 5% 1/10W
				R279	1-216-025-91	RES, CHIP	100 5% 1/10W



REF.NO.	PART NO.	DESCRIPTION	REMARK	REF.NO.	PART NO.	DESCRIPTION	REMARK
R280	1-216-067-00	RES, CHIP	5.6K 5% 1/10W	R1214	1-208-774-11	RES, CHIP	470 0.50% 1/10W
R281	1-216-025-91	RES, CHIP	100 5% 1/10W	R1215	1-208-776-11	RES, CHIP	560 0.50% 1/10W
R282	1-216-025-91	RES, CHIP	100 5% 1/10W	R1216	1-216-025-91	RES, CHIP	100 5% 1/10W
R283	1-216-049-91	RES, CHIP	1K 5% 1/10W	R1217	1-216-049-91	RES, CHIP	1K 5% 1/10W
R284	1-216-033-00	RES, CHIP	220 5% 1/10W	R1242	1-216-065-91	RES, CHIP	4.7K 5% 1/10W
R285	1-216-033-00	RES, CHIP	220 5% 1/10W	R1243	1-216-065-91	RES, CHIP	4.7K 5% 1/10W
R286	1-216-067-00	RES, CHIP	5.6K 5% 1/10W	R1244	1-216-049-91	RES, CHIP	1K 5% 1/10W
R287	1-216-025-91	RES, CHIP	100 5% 1/10W	R1245	1-216-049-91	RES, CHIP	1K 5% 1/10W
R288	1-216-067-00	RES, CHIP	5.6K 5% 1/10W	R1246	1-216-022-00	RES, CHIP	75 5% 1/10W
R289	1-216-067-00	RES, CHIP	5.6K 5% 1/10W	R1247	1-216-113-00	RES, CHIP	470K 5% 1/10W
R290	1-216-025-91	RES, CHIP	100 5% 1/10W	R1248	1-216-113-00	RES, CHIP	470K 5% 1/10W
R291	1-216-067-00	RES, CHIP	5.6K 5% 1/10W	R1249	1-216-113-00	RES, CHIP	470K 5% 1/10W
R292	1-216-025-91	RES, CHIP	100 5% 1/10W	R1250	1-216-065-91	RES, CHIP	4.7K 5% 1/10W
R293	1-216-025-91	RES, CHIP	100 5% 1/10W	R1251	1-216-049-91	RES, CHIP	1K 5% 1/10W
R294	1-216-077-00	RES, CHIP	15K 5% 1/10W	R1252	1-216-065-91	RES, CHIP	4.7K 5% 1/10W
R295	1-216-025-91	RES, CHIP	100 5% 1/10W	R1254	1-216-049-91	RES, CHIP	1K 5% 1/10W
R296	1-216-025-91	RES, CHIP	100 5% 1/10W	R1255	1-216-065-91	RES, CHIP	4.7K 5% 1/10W
R297	1-216-025-91	RES, CHIP	100 5% 1/10W	R1256	1-216-065-91	RES, CHIP	4.7K 5% 1/10W
R298	1-216-025-91	RES, CHIP	100 5% 1/10W	R1257	1-216-065-91	RES, CHIP	4.7K 5% 1/10W
R300	1-216-025-91	RES, CHIP	100 5% 1/10W	R1258	1-216-049-91	RES, CHIP	1K 5% 1/10W
R902	1-249-405-11	CARBON	100 5% 1/4W F	R1259	1-216-049-91	RES, CHIP	1K 5% 1/10W
R919	1-216-295-91	SHORT	0	R1260	1-216-295-91	SHORT	0
R921	1-249-405-11	CARBON	100 5% 1/4W F	R1261	1-208-774-11	RES, CHIP	470 0.50% 1/10W
R923	1-249-405-11	CARBON	100 5% 1/4W F	R1262	1-208-776-11	RES, CHIP	560 0.50% 1/10W
R925	1-249-405-11	CARBON	100 5% 1/4W F	R1263	1-216-295-91	SHORT	0
R926	1-216-049-91	RES, CHIP	1K 5% 1/10W	R1264	1-216-049-91	RES, CHIP	1K 5% 1/10W
R1051	1-216-073-00	RES, CHIP	10K 5% 1/10W	R1265	1-216-025-91	RES, CHIP	100 5% 1/10W
R1052	1-216-073-00	RES, CHIP	10K 5% 1/10W	R1266	1-216-041-00	RES, CHIP	470 5% 1/10W
R1055	1-216-073-00	RES, CHIP	10K 5% 1/10W	R1267	1-216-025-91	RES, CHIP	100 5% 1/10W
R1056	1-216-073-00	RES, CHIP	10K 5% 1/10W	R1268	1-216-049-91	RES, CHIP	1K 5% 1/10W
R1057	1-216-025-91	RES, CHIP	100 5% 1/10W	R1269	1-216-041-00	RES, CHIP	470 5% 1/10W
R1058	1-216-025-91	RES, CHIP	100 5% 1/10W	R1270	1-216-049-91	RES, CHIP	1K 5% 1/10W
R1059	1-216-065-91	RES, CHIP	4.7K 5% 1/10W	R1271	1-216-025-91	RES, CHIP	100 5% 1/10W
R1060	1-216-073-00	RES, CHIP	10K 5% 1/10W	R1272	1-208-774-11	RES, CHIP	470 0.50% 1/10W
R1062	1-216-025-91	RES, CHIP	100 5% 1/10W	R1273	1-208-777-11	RES, CHIP	620 0.50% 1/10W
R1063	1-216-073-00	RES, CHIP	10K 5% 1/10W	R1274	1-216-049-91	RES, CHIP	1K 5% 1/10W
R1064	1-216-073-00	RES, CHIP	10K 5% 1/10W	R1275	1-216-097-91	RES, CHIP	100K 5% 1/10W
R1065	1-216-025-91	RES, CHIP	100 5% 1/10W	R1276	1-216-041-00	RES, CHIP	470 5% 1/10W
R1156	1-216-073-00	RES, CHIP	10K 5% 1/10W	R1277	1-216-025-91	RES, CHIP	100 5% 1/10W
R1157	1-216-073-00	RES, CHIP	10K 5% 1/10W	R1278	1-216-025-91	RES, CHIP	100 5% 1/10W
R1191	1-216-017-91	RES, CHIP	47 5% 1/10W	R1279	1-216-025-91	RES, CHIP	100 5% 1/10W
R1192	1-216-017-91	RES, CHIP	47 5% 1/10W	R1280	1-216-025-91	RES, CHIP	100 5% 1/10W
R1208	1-216-049-91	RES, CHIP	1K 5% 1/10W	R1281	1-216-049-91	RES, CHIP	1K 5% 1/10W
R1209	1-216-295-91	SHORT	0	R1282	1-216-025-91	RES, CHIP	100 5% 1/10W
R1211	1-216-089-91	RES, CHIP	47K 5% 1/10W	R1283	1-216-295-91	SHORT	0
R1212	1-216-081-00	RES, CHIP	22K 5% 1/10W	R1284	1-216-295-91	SHORT	0
R1213	1-216-049-91	RES, CHIP	1K 5% 1/10W	R1286	1-216-295-91	SHORT	0



REF.NO.	PART NO.	DESCRIPTION	REMARK			REF.NO.	PART NO.	DESCRIPTION	REMARK		
R1287	1-216-295-91	SHORT	0			C966	1-163-021-91	CERAMIC CHIP	0.01MF	10%	50V
R1288	1-216-295-91	SHORT	0			C967	1-136-165-00	FILM	0.1MF	5%	50V
R1289	1-216-295-91	SHORT	0			C968	1-163-021-91	CERAMIC CHIP	0.01MF	10%	50V
R1290	1-216-295-91	SHORT	0			C970	1-163-021-91	CERAMIC CHIP	0.01MF	10%	50V
R1291	1-216-295-91	SHORT	0			C971	1-104-664-11	ELECT	47MF	20%	25V
R1292	1-216-295-91	SHORT	0			C972	1-163-251-11	CERAMIC CHIP	100PF	5%	50V
R1293	1-216-049-91	RES, CHIP	1K	5%	1/10W	C973	1-163-021-91	CERAMIC CHIP	0.01MF	10%	50V
R1294	1-216-049-91	RES, CHIP	1K	5%	1/10W	C974	1-137-370-11	FILM	0.01MF	5%	50V
R1295	1-216-049-91	RES, CHIP	1K	5%	1/10W	C976	1-130-967-00	FILM	0.0027MF	5%	50V
R1296	1-216-049-91	RES, CHIP	1K	5%	1/10W	C977	1-104-760-11	CERAMIC CHIP	0.047MF	10%	50V
R1297	1-216-049-91	RES, CHIP	1K	5%	1/10W	C981	1-126-941-11	ELECT	470MF	20%	25V
R1298	1-216-049-91	RES, CHIP	1K	5%	1/10W	C983	1-137-366-11	FILM	0.0022MF	5%	50V
R1299	1-216-049-91	RES, CHIP	1K	5%	1/10W	C984	1-107-713-11	ELECT	4.7MF	20%	35V
R1300	1-216-049-91	RES, CHIP	1K	5%	1/10W	C1941	1-126-941-11	ELECT	470MF	20%	25V
R140T	1-216-073-00	RES, CHIP	10K	5%	1/10W	C1948	1-164-161-11	CERAMIC CHIP	0.0022MF	10%	50V
R1411	1-216-073-00	RES, CHIP	10K	5%	1/10W	C1961	1-129-725-00	FILM	0.082MF	5%	400V
R1412	1-216-093-00	RES, CHIP	68K	5%	1/10W	C1962	1-163-021-91	CERAMIC CHIP	0.01MF	10%	50V
R1414	1-216-077-00	RES, CHIP	15K	5%	1/10W	C1965	1-136-601-11	FILM	0.01MF	10%	630V
R1416	1-216-025-91	RES, CHIP	100	5%	1/10W	C1966	1-137-378-11	FILM	0.22MF	5%	50V
R1417	1-216-025-91	RES, CHIP	100	5%	1/10W	C1968	1-137-378-11	FILM	0.22MF	5%	50V
R1418	1-216-093-00	RES, CHIP	68K	5%	1/10W	C1969	1-163-021-91	CERAMIC CHIP	0.01MF	10%	50V
R1419	1-216-077-00	RES, CHIP	15K	5%	1/10W	C1972	1-104-664-11	ELECT	47MF	20%	16V
R2201	1-216-022-00	RES, CHIP	75	5%	1/10W	C1974	1-104-664-11	ELECT	47MF	20%	16V
R2202	1-216-022-00	RES, CHIP	75	5%	1/10W	C1976	1-163-035-00	CERAMIC CHIP	0.047MF	50V	
R2203	1-216-022-00	RES, CHIP	75	5%	1/10W						



- \* A-1375-179-A WA BOARD, COMPLETE (KV-32XBR200)  
 \* A-1375-181-A WA BOARD, COMPLETE (KV-36XBR200)

#### CAPACITOR

C944	1-163-021-91	CERAMIC CHIP	0.01MF	10%	50V
C946	1-104-665-11	ELECT	100MF	20%	25V
C949	1-161-830-00	CERAMIC	0.0047MF		500V
C950	1-126-941-11	ELECT	470MF	20%	25V
C951	1-107-637-11	ELECT	22MF	20%	160V
C952	1-104-999-11	MYLAR	0.1MF	10%	200V
C953	1-106-383-00	MYLAR	0.047MF	10%	200V
C954	1-130-471-00	FILM	0.001MF	5%	50V
C955	1-107-667-11	ELECT	2.2MF	20%	160V
C956	1-130-471-00	FILM	0.001MF	5%	50V
C957	1-106-383-00	MYLAR	0.047MF	10%	200V
C958	1-126-941-11	ELECT	470MF	20%	25V
C963	1-126-960-11	ELECT	1MF	20%	50V
C964	1-136-153-00	FILM	0.01MF	5%	50V
C965	1-136-165-00	FILM	0.1MF	5%	50V

#### CONNECTOR

CN941 *	1-564-511-11	PLUG, CONNECTOR 8P
CN942 *	1-564-509-11	PLUG, CONNECTOR 6P
CN961 *	1-770-723-11	CONNECTOR, BOARD TO BOARD 8P
CN981 *	1-564-506-11	PLUG, CONNECTOR 3P
CN982 *	1-564-507-11	PLUG, CONNECTOR 4P

#### DIODE

D941	8-719-991-33	DIODE 1SS133T-77
D946	8-719-110-88	DIODERD39ESB2
D947	8-719-110-88	DIODERD39ESB2
D962	8-719-991-33	DIODE 1SS133T-77
D963	8-719-404-49	DIODE MA111
D964	8-719-210-21	DIODE 11EQS04
D966	8-719-302-43	DIODE EL1Z
D968	8-719-109-89	DIODERD5.6ESB2
D969	8-719-109-89	DIODERD5.6ESB2
D1961	8-719-991-33	DIODE 1SS133T-77
D1962	8-719-991-33	DIODE 1SS133T-77

#### IC

IC961	8-752-074-64	ICXA2026AS
IC962	8-759-729-03	ICNJM2903D



REF.NO.	PART NO.	DESCRIPTION	REMARK	REF.NO.	PART NO.	DESCRIPTION	REMARK
IC963	8-759-729-03	ICNJM2903D		R968	1-216-083-00	RES, CHIP	27K 5% 1/10W
IC964	8-759-700-42	ICNJM2904D		R969	1-216-025-91	RES, CHIP	100 5% 1/10W
IC965	8-759-701-59	ICNJM78M09FA		R970	1-208-832-11	RES, CHIP	120K 0.50% 1/10W
IC981	8-759-603-37	ICM5216P		R971	1-216-049-91	RES, CHIP	1K 5% 1/10W
	<b>COIL</b>			R972	1-216-065-91	RES, CHIP	4.7K 5% 1/10W
L961	1-459-111-00	INDUCTOR	OUH	R973	1-216-057-00	RES, CHIP	2.2K 5% 1/10W
L964	1-406-989-21	INDUCTOR	10MMH	R974	1-208-808-11	RES, CHIP	12K 0.50% 1/10W
	<b>TRANSISTOR</b>			R975	1-216-073-00	RES, CHIP	10K 5% 1/10W
Q943	8-729-422-27	TRANSISTOR2SD601A-Q		R976	1-216-057-00	RES, CHIP	2.2K 5% 1/10W
Q944	8-729-422-27	TRANSISTOR2SD601A-Q		R977	1-249-401-11	CARBON	47 5% 1/4W F
Q945	8-729-422-27	TRANSISTOR2SD601A-Q		R978	1-216-073-00	RES, CHIP	10K 5% 1/10W
Q946	8-729-017-05	TRANSISTOR2SA1837		R979	1-216-017-91	RES, CHIP	47 5% 1/10W
Q947	8-729-017-06	TRANSISTOR2SC4793		R980	1-216-073-00	RES, CHIP	10K 5% 1/10W
Q961	8-729-119-78	TRANSISTOR2SC2785-HFE		R981	1-216-085-00	RES, CHIP	33K 5% 1/10W
Q962	8-729-119-76	TRANSISTOR2SA1175-HFE		R982	1-216-081-00	RES, CHIP	22K 5% 1/10W
Q963	8-729-119-76	TRANSISTOR2SA1175-HFE		R983	1-216-077-00	RES, CHIP	15K 5% 1/10W
Q965	8-729-931-45	TRANSISTORIRF614		R984	1-216-069-00	RES, CHIP	6.8K 5% 1/10W
Q966	8-729-216-22	TRANSISTOR2SA1162-G		R985	1-215-421-00	METAL	1K 1% 1/4W
Q967	8-729-140-97	TRANSISTOR2SB734-34		R987	1-216-049-91	RES, CHIP	1K 5% 1/10W
Q968	8-729-422-27	TRANSISTOR2SD601A-Q		R988	1-215-429-00	METAL	2.2K 1% 1/4W
Q969	8-729-119-78	TRANSISTOR2SC2785-HFE		R989	1-208-806-11	RES, CHIP	10K 0.50% 1/10W
Q981	8-729-422-27	TRANSISTOR2SD601A-Q		R990	1-216-025-91	RES, CHIP	100 5% 1/10W
Q1961	8-729-140-97	TRANSISTOR2SB734-34		R991	1-208-800-11	RES, CHIP	5.6K 0.50% 1/10W
	<b>RESISTOR</b>			R992	1-216-073-00	RES, CHIP	10K 5% 1/10W
R943	1-216-025-91	RES, CHIP	100 5% 1/10W	R993	1-216-025-91	RES, CHIP	100 5% 1/10W
R948	1-216-049-91	RES, CHIP	1K 5% 1/10W	R1941	1-260-312-11	CARBON	47 5% 1/2W
R949	1-216-057-00	RES, CHIP	2.2K 5% 1/10W	R1942	1-249-387-11	CARBON	3.3 5% 1/4W F
R950	1-216-049-91	RES, CHIP	1K 5% 1/10W	R1943	1-249-414-11	CARBON	560 5% 1/4W F
R951	1-216-049-91	RES, CHIP	1K 5% 1/10W	R1944	1-249-432-11	CARBON	18K 5% 1/4W
R952	1-216-041-00	RES, CHIP	470 5% 1/10W	R1945	1-215-914-11	METAL OXIDE	330 5% 3W F
R953	1-216-021-00	RES, CHIP	68 5% 1/10W	R1946	1-249-417-11	CARBON	1K 5% 1/4W F
R954	1-216-033-00	RES, CHIP	220 5% 1/10W	R1947	1-249-432-11	CARBON	18K 5% 1/4W
R955	1-216-047-91	RES, CHIP	820 5% 1/10W	R1948	1-249-414-11	CARBON	560 5% 1/4W
R956	1-216-025-91	RES, CHIP	100 5% 1/10W	R1949	1-249-387-11	CARBON	3.3 5% 1/4W F
R957	1-216-073-00	RES, CHIP	10K 5% 1/10W	R1950	1-249-401-11	CARBON	47 5% 1/4W F
R958	1-216-025-91	RES, CHIP	100 5% 1/10W	R1960	1-216-037-00	RES, CHIP	330 5% 1/10W
R959	1-216-021-00	RES, CHIP	68 5% 1/10W	R1962	1-216-065-91	RES, CHIP	4.7K 5% 1/10W
R961	1-216-025-91	RES, CHIP	100 5% 1/10W	R1963	1-216-033-00	RES, CHIP	220 5% 1/10W
R962	1-216-025-91	RES, CHIP	100 5% 1/10W	R1964	1-216-057-00	RES, CHIP	2.2K 5% 1/10W
R963	1-216-091-00	RES, CHIP	56K 5% 1/10W	R1967	1-215-489-00	METAL	680K 1% 1/4W
R964	1-216-109-00	RES, CHIP	330K 5% 1/10W	R1969	1-216-057-00	RES, CHIP	2.2K 5% 1/10W
R965	1-216-089-91	RES, CHIP	47K 5% 1/10W	R1970	1-216-049-91	RES, CHIP	1K 5% 1/10W
R966	1-216-073-00	RES, CHIP	10K 5% 1/10W	R1971	1-216-121-91	RES, CHIP	1M 5% 1/10W
R967	1-216-089-91	RES, CHIP	47K 5% 1/10W	R1972	1-216-073-00	RES, CHIP	10K 5% 1/10W
				R1973	1-216-035-00	RES, CHIP	270 5% 1/10W
				R1974	1-216-077-00	RES, CHIP	15K 5% 1/10W
				R1978	1-216-025-91	RES, CHIP	100 5% 1/10W

**Note:**

The components identified with shading and a critical symbol  $\triangle$  are critical for safety. Replace only with part number specified.

**Note:**

Les composants identifiés par un trame et une marque  $\triangle$  sont critiques pour la sécurité. Ne les remplacer que par une pièce portant le numéro spécifié.

REF.NO.	PART NO.	DESCRIPTION	REMARK
R1980	1-216-041-00	RES, CHIP	470 5% 1/10W
R2962	1-215-885-00	METAL OXIDE	68 5% 2W F
R2963	1-215-885-00	METAL OXIDE	68 5% 2W F
R2965	1-216-065-91	RES, CHIP	4.7K 5% 1/10W
R2966	1-208-842-11	RES, CHIP	330K 0.50% 1/10W
R2967	1-208-839-11	RES, CHIP	240K 0.50% 1/10W (KV-32XBR200)
R2967	1-208-841-11	RES, CHIP	300K 0.50% 1/10W (KV-36XBR200)
R2968	1-216-065-91	RES, CHIP	4.7K 5% 1/10W
R2969	1-216-065-91	RES, CHIP	4.7K 5% 1/10W
R2971	1-216-069-00	RES, CHIP	6.8K 5% 1/10W
R2972	1-208-784-11	RES, CHIP	1.2K 0.50% 1/10W
R2973	1-208-758-11	RES, CHIP	100 0.50% 1/10W
R2975	1-216-061-00	RES, CHIP	3.3K 5% 1/10W
R2976	1-208-758-11	RES, CHIP	100 0.50% 1/10W
R2977	1-216-073-00	RES, CHIP	10K 5% 1/10W
R2978	1-208-782-11	RES, CHIP	1K 0.50% 1/10W
R2979	1-216-097-91	RES, CHIP	100K 5% 1/10W
R2980	1-216-097-91	RES, CHIP	100K 5% 1/10W

REF.NO.	PART NO.	DESCRIPTION	REMARK
---------	----------	-------------	--------

ACCESSORIES AND PACKING MATERIALS

	3-862-739-21	MANUAL, INSTRUCTION	
*	4-065-856-01	CUSHION (UPPER) (ASSY) (KV-32XBR200)	
*	4-065-857-01	CUSHION (LOWER) (ASSY) (KV-32XBR200)	
*	4-053-658-01	BAG, PROTECTION (KV-32XBR200)	
*	4-065-855-01	INDIVIDUAL CARTON (KV-32XBR200)	
*	4-065-046-01	CUSHION (UPPER) (ASSY) (KV-36XBR200)	
*	4-065-047-01	CUSHION (LOWER) (ASSY) (KV-36XBR200)	
*	4-066-646-01	BAG, PROTECTION (KV-36XBR200)	
*	4-066-647-01	INDIVIDUAL CARTON (KV-36XBR200)	
*	4-066-648-01	CUSHION (REAR) (KV-36XBR200)	

REMOTE COMMANDER

	1-475-306-11	REMOTE COMMANDER (RM-Y144)	
	4-978-977-01	BATTERY COVER	

MISCELLANEOUS

$\triangle$	1-416-827-11	COIL, DEMAGNETIZATION (KV-32XBR200)	
$\triangle$	1-416-828-11	COIL, DEMAGNETIZATION (KV-36XBR200)	
	1-452-032-00	MAGNET, DISK 10MMØ	
	1-452-094-00	MAGNET, ROTABLE DISK: 15MMØ	
	1-452-885-11	MAGNET, LANDING	
	1-557-056-31	CABLE, P-P	
	1-556-945-21	CABLE, P-P	
$\triangle$	1-751-059-11	CORD, POWER	
	8-598-414-00	ANTENNA SWITCH	
$\triangle$	8-735-047-61	ITC34RSN-A1 (KV-32XBR200)	
$\triangle$	8-735-048-61	ITC38RSN-A1 (KV-36XBR200)	
$\triangle$	1-453-282-11	TRANSFORMER, FLYBACK (KV-32XBR200)	
$\triangle$	1-453-286-11	TRANSFORMER, FLYBACK (KV-36XBR200)	

